

# OPERATOR'S MANUAL

# G36 .22 LR



HECKLER ★ KOCH

Caliber .22 LR  
Semi-Automatic Firearm

Made in Germany by Umarex



**WARNING:** Read the instructions and warnings in this manual carefully before using this firearm.



All technical changes and modifications reserved.



# **G36 .22 LR**

## **OPERATOR'S MANUAL**

This **INSTRUCTION MANUAL** should always accompany the firearm and be transferred with it upon change of ownership or when presented to another person. A copy of the **INSTRUCTION MANUAL** is available **FREE** upon request from:

**HECKLER & KOCH**  
5675 Transport Boulevard  
Columbus, Georgia 31907  
Customer Service: 706-701-5554  
USA Website: [www.hk-usa.com](http://www.hk-usa.com) • Email: [cs@heckler-koch-us.com](mailto:cs@heckler-koch-us.com)

## TABLE OF CONTENTS

1.1	Safety Rules .....	5
1.2	Safety Operating Instructions .....	8
1.3	Storage And Transport .....	11
1.4	Preparation Of Firing .....	12
1.5	Ammunition .....	13
1.6	Manual Safety .....	14
2.1	Inspection .....	15
2.2	Loading The Firearm .....	15
2.3	Loading The chamber with the first cartridge .....	16
2.4	Firing .....	17
2.5	Decocking .....	18
2.6	Manual Bolt Catch .....	19
2.7	Firearm With Empty Magazine .....	20
2.8	Unloading .....	20
2.9	Clearing misfire .....	21
3.1	Settings – Rear Sight .....	21
3.2	Settings – Stock .....	23
4	Mounting An Optical Sight .....	23
5.1	Field Stripping .....	24
5.2	Maintenance .....	25
5.3	Storage .....	26
5.4	Warranty / repair .....	27
6.1	Technical data .....	30
6.2	Variants .....	31
6.3	Nomenclature .....	32
7.1	Youth handgun safety notice .....	34
7.2	State required safety notices .....	36
	Contact.....	Back

Read this entire operator's manual carefully and thoroughly before using, handling, or loading your firearm. The warnings and instructions in this operator's manual are important. Firearm safety is YOUR responsibility. DO NOT use this firearm if you DO NOT fully understand the warnings and instructions in this operator's manual. Firearms can be dangerous if not handled properly and safely. Failure to follow the warnings and instructions in this operator's manual, or the improper use of this firearm, may result in serious injury or death, damage to the firearm, or other damage to property. This manual should always accompany your G36 .22LR firearm if it is sold, given, or loaned to another person. Whether you are an experienced shooter or have never handled a firearm before, you must read this entire manual carefully before handling, loading, or firing your G36 .22LR firearm. Your safety and the safety of others depends upon you following the instructions and warnings in this manual and constant use of safe firearms practices. If you are unfamiliar with firearms, take a course in the safe handling of firearms conducted by a qualified firearms instructor, your local gun club, or a similar qualified organization.

This manual contains safety warnings and instructions preceded with, **▲WARNING**, **▲CAUTION** or **NOTICE** symbols. These signal words are designed to draw your attention to important safety information.

**▲WARNING** Indicates a hazardous situation which, if not avoided, could result in death or serious personal injury.

**▲CAUTION** Indicates a hazardous situation which, if not avoided, could result in moderate or minor personal injury.

**NOTICE** Indicates safety practices not related to personal injury.

---

### These Warnings, Cautions and Notices will apply at all times.

**▲WARNING** Failure to follow the safety information and instructions in this manual could result in death, serious personal injury and/or property damage.

**▲WARNING** Treat all firearms as if they are ALWAYS loaded. If any firearm is handled carelessly or improperly, you could cause a negligent discharge, which could result in death, serious personal injury, and/or property damage.

**▲WARNING** Keep your finger off the trigger and outside of the trigger guard until your sights are aligned on the target and you are ready to fire.

**▲WARNING** Keep your finger off the trigger and outside of the trigger guard while loading or unloading the firearm.

**▲WARNING** Keep your finger off the trigger and outside of the trigger guard while pulling the firearm out of the holster or while returning it to the holster.

**▲WARNING** Be sure of your target, backstop, and what is beyond.

- ▲WARNING** NEVER give a firearm to or take a firearm from anyone unless the action is open, and the magazine and chamber are free of any ammunition or brass.
- ▲WARNING** NEVER take anyone's word that a firearm is unloaded. ALWAYS check for yourself, with the firearm pointed in a safe direction and your finger off of the trigger and outside the trigger guard.
- ▲WARNING** Be sure that the ammunition you are using is factory loaded, is of the correct caliber for the firearm in which it is to be used, and that it is not damaged in any way.
- ▲WARNING** Before firing, remove the magazine from the firearm, lock the action open, make sure the chamber is CLEAR of any ammunition or brass, and check the barrel of the unloaded firearm for any possible obstructions.
- ▲WARNING** Before firing any firearm that is unfamiliar to you, make sure that you understand exactly how it functions. A lack of familiarity with the firearm can result in serious injury or death, damage to the firearm or other damage to property. Attend a certified training course on any firearm which you intend to use or with which you are not sufficiently familiar.
- ▲WARNING** ALWAYS wear hearing and eye protection when using your firearm.
- ▲WARNING** Firearms should be locked and stored unloaded, secured, and separately from ammunition in a suitable container out of the sight and reach of children and/or any unauthorized individuals.
- ▲WARNING** Never store or transport ammunition in the same container as your firearm.
- ▲WARNING** Alcohol or drugs should NEVER be used before or during use or handling of a firearm. Your vision, balance, coordination, and judgement could be seriously impaired, making your firearm handling unsafe.
- ▲WARNING** If or when you are taking medication, ALWAYS seek a doctor's advice to be sure you are able to use and handle your firearm properly and safely.
- ▲WARNING** NEVER alter or modify your firearm because alterations or modifications may impair the use of the firearm, including causing malfunctions or dangerous conditions.
- ▲WARNING** Discharging firearms in poorly ventilated areas, cleaning firearms, or handling ammunition may result in exposure to lead; a substance known to be associated with birth defects, reproductive harm and other serious injury or death. Always have adequate ventilation. Wash hands thoroughly after handling ammunition, firing your firearm, and/or performing preventative maintenance on your firearm to minimize your lead exposure.
- ▲CAUTION** Keep all body parts, including the hands and fingers, away from the muzzle to avoid injury or burns.

**⚠ CAUTION**

Be sure that no part of either hand touches or interferes with the slide. The slide is moved backward by the recoil force of the firearm during firing and may cause serious injury.

**Not all HK products are available to all U.S. states. Please check local laws and regulations before ordering. Heckler & Koch does not warrant that a person may legally purchase, possess, or carry specific items according to federal, state, or local laws.**

**Before leaving the factory, your G36 .22LR firearm was tested, carefully inspected, and packaged. However, HK cannot control what happens to its firearms after they leave the factory, therefore, carefully examine your G36 .22LR firearm when you acquire it to ensure that it is unloaded and undamaged.**

If you need another copy of this manual, do not understand any of the warnings or instructions, or if you have any problems operating your HK firearm, contact us at:

**HECKLER & KOCH**

5675 Transport Boulevard

Columbus, Georgia 31907

Customer Service: 706-701-5554

USA Website: [www.hk-usa.com](http://www.hk-usa.com) • Email: [cs@heckler-koch-us.com](mailto:cs@heckler-koch-us.com)

---

**Safety is your number one responsibility!**

---

**At home, in the field, at the range, or anywhere, the first concern of every firearm owner should be safety. Apply the following safety rules in every situation, with any kind of firearm.**

---

**You must follow all of these safety rules to ensure the safe use of your firearm.**

---

---

**Safe gun handling is your personal responsibility!**

---

Safe use of a firearm is your personal responsibility and the failure to follow all of these basic safety rules may result in severe personal injury or death to you or others. You are the most important safety device when it comes to the use of your firearm. HECKLER & KOCH will not be responsible for any personal injury, death or property damage that results from:

1. The criminal or negligent use of this firearm;
  2. A disregard of these safety instructions and warnings;
  3. Improper or careless handling of this firearm;
  4. The use of non-standard, defective, improper or reloaded ammunition; or
  5. Improper or negligent modifications or repair to the firearm.
- **Safe gun handling is your personal responsibility at all times.** Firearms are dangerous and can cause serious injury or death if they are misused or used inappropriately. Safety must be the first consideration of anyone who owns or handles firearms.
  - **You are responsible for firearm safety at all times.** You must undertake full-time responsibility for your firearms safety and security. You must protect yourself and all others against injury or death from misuse of the firearm.
  - **Safe firearm storage is your responsibility.** You must secure firearms safely from children and unauthorized users. A lock has been provided for use with this firearm. Never assume that the use of this lock is sufficient to safely secure your firearm. You must always evaluate your personal situation and employ the security system(s) that meet your needs and prevent children and unauthorized users from gaining access to your firearm.
  - **Accidents are the result of violating the rules of safe gun handling and common sense.** For your safety and the safety of others, never rely on mechanical features alone. Only your safe gun handling habits will ensure the safe use of the firearm. This is your responsibility.
  - **Never keep ammunition in the same location as the firearm.** Store in a separate and secure place.

- **Do not alter, modify or replace any of the parts of the internal components of your firearm.** All work must be performed by a HECKLER & KOCH authorized gunsmith. If you do otherwise, improper functioning may occur, serious injury or death may result, and your warranty will be voided.
- **Never manipulate, adjust or change any of the internal components of your firearm including the firing pin, sear, or drawbar.** Improper manipulation of any internal component may affect the safety and reliability of your firearm and may cause serious injury.
- **Read and understand these instructions before using your firearm.**

---

**▲WARNING** The failure to follow these basic firearm safety rules may result in an unintended discharge which could cause serious personal injury or death to you and others.

---

- **Before handling any firearm, understand its operation.** Not all firearms are the same. Familiarize yourself with the mechanical features of any firearm you intend to use. If you feel uncertain about any operational aspects of your firearm, please contact HECKLER & KOCH before proceeding with its operation.
- **Always safely store and secure your firearm.** Safe and secure storage of your firearm is one of the most important responsibilities of firearm ownership. It is a full-time responsibility. You must always secure your firearm and ammunition separately so that they are not accessible to children or other unauthorized persons. (See safe storage instructions in this manual).
- **Always keep your firearm pointed in a safe direction.** Never point this firearm at any person. Never point at anything you do not intend to shoot whether or not the firearm is loaded. This is particularly important when loading, unloading, or field stripping the gun.
- **Always control the direction of the muzzle.**
- **Never place your finger on the trigger or inside the trigger guard unless you intend to fire.** Ensure that other objects do not touch the trigger.
- **Always be sure of your target and what is beyond it.** Always be sure of where the bullet will strike and shoot only where there is a safe backstop free of obstructions, water or other surfaces which can cause ricochets. Think of what the bullet may hit if it misses the target or ricochets. Do not fire into the sky.
- **Never disassemble your firearm or manipulate the internal components of your firearm beyond the field stripping procedure outlined in this manual.** Improper disassembly or manipulation of your firearm may be dangerous and can lead to serious injury or death.

- **Never carry or store a firearm with the hammer or striker in the cocked position.**
- **Never allow your firearm to be used by individuals who have not read or do not understand these firearm safety rules.**
- **Be sure all accessories, such as holsters and grips, are compatible with the firearm** and that the accessories do not interfere with the safe operation.
- **Always use the correct ammunition for your particular firearm as indicated by the marking on the barrel or receiver.** Never use non-standard, reloaded, or “handloaded” ammunition which has not been subjected to internal ballistic pressure testing.
- **Always have adequate ventilation.** Discharging firearms in poorly ventilated areas, cleaning firearms, or handling ammunition may result in exposure to lead and other substances known to cause birth defects, reproductive harm, and other serious physical injury. Review the warning and labels for all ammunition and cleaning products carefully.
- **Never consume alcohol or drugs before or while shooting.** Do not use your firearm if you are on any medication which impairs, even slightly, your mental and/or physical ability.
- **Always wear eye and hearing protection specified for firearm use every time you discharge your firearm.** Make sure others in the vicinity of where you will be shooting wear protection as well.
- **Never allow any alteration or replacement of parts in your firearm unless performed by a qualified HECKLER & KOCH gunsmith.** If you do otherwise, improper functioning of your firearm may occur and serious injury or death may result.
- **Never cross obstacles such as fences or streams with a loaded firearm.**
- Firearm safety training is available. Contact your dealer, law enforcement agency, local sportman’s club, or the nra for availability.
- **Appropriate use for your firearm means using your firearm for legal purposes.**

---

**▲WARNING** The firearm is not **EMPTY** or unloaded until the magazine is removed and the chamber is **CLEAR**. It is possible that a cartridge may be in the chamber when a magazine is being removed from or inserted into your firearm. A cartridge in the chamber will discharge when the trigger is pulled, whether or not a magazine is in your firearm. **NEVER** leave your firearm unattended, even when the magazine is removed. You must **ALWAYS** verify that the chamber is empty before disassembling your firearm for cleaning or any other purpose.

---

**▲WARNING** Firearms should be locked and stored unloaded, secured, and separately from ammunition in a suitable container out of the sight and reach of children and/ or any unauthorized individuals.

---

**▲WARNING** **NEVER** store or transport ammunition in the same container as your firearm.

---

**▲WARNING** **NEVER** rely solely on a mechanical device or your memory to determine whether your firearm is loaded. **ALWAYS** remove the magazine, retract and lock the slide by pulling it fully to the rear and locking it open, and then visually and physically check with your finger to ensure there is not a cartridge in the chamber.

---

1. Store or transport the firearm and its components clean and lubricated.
2. Store and transport the firearm without cartridges in the chamber, magazine, or in the storage container with the magazine removed.
3. Store and transport the firearm with the slide in the forward (closed) position.
4. Clean and lubricate the firearm and its components at least every twelve (12) months during storage.
5. HK recommends storage in a climate controlled, room temperature environment.
6. Store the firearm and ammunition separately under lock and key.

#### **TROUBLESHOOTING PROBLEMS AND REPAIR**

Common causes of problems that are often overlooked include:

- Fouled or improperly lubricated firearm
- Bad ammunition
- Damaged magazines
- Operator error

If your firearm still fails to function, please contact HK Customer Service at 706-701-5554. Law enforcement users, contact your unit armorer or HK Customer Service.

---

**NOTICE** If after reviewing this manual you still have questions, please contact HK Customer Service at 706-701-5554 or by email: [cs@heckler-koch-us.com](mailto:cs@heckler-koch-us.com).

---

---

**▲WARNING** The failure to follow these firearm safety requirements will cause serious injury or death to you or others.

---

- **Always wear adequate and proper ear protection specified for firearm use** to prevent permanent damage to your hearing. Make sure others who are nearby are wearing ear protection as well.
- **Always wear safety glasses specified for firearm use, whether indoors or out.** Safety glasses should protect your eyes from the muzzle flash and particles associated with the discharge of ammunition. Failure to do so creates a risk of personal injury from particle or debris ejection or ricochets.
- **Never shoot at hard surfaces, water or up into the sky.** Always select a place to shoot that has a safe backstop and is free from obstruction and water surfaces which cause ricochets.
- **Always be aware of people around you** so that persons cannot accidentally walk into the line of fire.
- **Always position the shooter so that all others are out of the line of fire** and are not within an area where they may be struck by ricochets, or by ejected cases.
- **Always keep fingers and other parts of your body away from the muzzle and away from the firearm bolt and ejection port.**
- **Always be alert and always follow the safety instructions of the shooting range officer.**
- **Always be sure that the action of the firearm is open, the chamber is clear of ammunition, magazine is removed, and the firearm is pointing in a safe direction.**
- **Always be alert.** Never shoot if you are tired, cold or impaired in any way.
- **Always treat your firearm as if it were loaded.**
- **Never consume alcohol or drugs before or while shooting.**

**a) General principles**

- There are different types of ammunition for different types of firearms. Your firearm has been designed for ammunition of a specific type and a specific caliber. It is important to select the proper ammunition for your firearm.

---

**▲WARNING** Never use ammunition not specifically designated for use in your firearm. Failure to use the correct type or caliber of ammunition may cause the firearm to jam, fail to fire or even generate excessive pressure which can damage or even rupture your firearm, causing personal injury, death or property damage.

---

- You are responsible for selecting ammunition that meets industry standards and is appropriate in type and caliber for this firearm.
- Locate the caliber designation marked on the left side of the upper receiver. This information indicates the ammunition caliber that should be used in this firearm.

**b) Handloaded or reloaded ammunition**

---

**▲WARNING** Never use non-standard, reloaded or “handloaded” ammunition which has not been subjected to internal ballistic pressure testing. Reloaded or handloaded ammunition may have many manufacturing and quality variables (such as the type and amount of gun powder). Any ammunition that is improperly manufactured, even in the slightest degree, may fail to fire or may generate excessive internal pressures which can damage or even rupture the firearm, causing personal injury or death to the shooter or those in the immediate vicinity.

---

- The G36 .22LR is chambered for .22LR ammunition and will function safely and reliably with most .22LR HV (High Velocity) ammunition. Use only commercially manufactured ammunition with internal ballistic pressure which are in strict accordance with the specifications of the Sporting Arms and Ammunition Manufacturers Institute (SAAMI). If you are uncertain, contact your ammunition supplier for verification.

**c) Ammunition specifications**

- Use only ammunition specifically recommended for your firearm.
- Never mix ammunition.
- Never use a cartridge not specifically designated for use in your firearm.
- Pressure from the wrong type of ammunition may exceed the capability of your firearm and may damage or even rupture your firearm.
- In some cases, a round of ammunition not specified on your firearm may fit into the chamber. Firing ammunition not specified on your firearm may cause it to rupture and cause serious injury or death to you or others.

## 1.5

## AMMUNITION

- Always inspect your ammunition before using it. Never use dirty, corroded or damaged ammunition which can lead to a burst cartridge which may cause damage to the firearm and personal injury or death.

**▲WARNING** .22 LR caliber cartridges have a wide range of loads, from very weak for sport shooting and maximum precision to very powerful for a high projectile velocity. To ensure reliable operation, a semi-automatic firearm must be matched to a certain cartridge load. For this reason the cal. .22 LR HK G36 has been designed for high-quality standard ammunition and HV (High Velocity) ammunition, and one can be sure of trouble-free operation only with these types. Please note that these firearms are not designed for the use of cal. .22 extra-long ammunition.

## 1.6

## MANUAL SAFETY

**▲WARNING** Always leave the manual safety engaged (on “SAFE”) until you intend to fire.



**SAFE Position** rotate the safety lever so the indicator is pointing to the word SAFE.



**FIRE Position** rotate the safety lever so the indicator is pointing to the word FIRE.

The safety can be operated from both sides of the firearm.

**▲WARNING** Never rely solely on mechanical features alone - always be extremely careful, use safe gun handling practices, and avoid situations which could lead to an accident. Always inspect the chamber of your firearm after the magazine has been removed from the gun. Make sure that no cartridge is left in the chamber.

## 2.1

## INSPECTION

**▲WARNING** Before inspection, make sure that the firearm is always pointed in a safe direction, is on "SAFE", and is unloaded (magazine removed, chamber cleared, empty chamber indicator (red tab) is installed, and barrel clear of any obstructions).

**▲WARNING** Keep all body parts, including hands and fingers, away from the muzzle to avoid injury or burns.

### Functional Inspection

1. Bolt movement: Remove the magazine and retract the bolt by pulling back the charging handle. Release the charging handle to return the bolt fully forward into battery.
2. Bolt catch: Insert the empty magazine, retract the bolt by pulling back the charging handle. The bolt locks back in rearmost position.
3. Decocking: Make sure that the firearm is on "SAFE" and unloaded (magazine removed, chamber cleared, empty chamber indicator (red tab) is installed, and barrel clear of any obstructions)! Pull charging handle rearward and then release allowing it to freely move forward. Place safety in the "FIRE" position, make sure the muzzle is pointed in a safe direction. Pull the trigger. The hammer drops to a de-cocked position. Put back on "SAFE".

## 2.2

## LOADING THE FIREARM

**▲WARNING** Before loading, make sure that the firearm is always pointed in a safe direction, is on "SAFE", and is unloaded (magazine removed, chamber cleared and barrel clear of any obstructions).

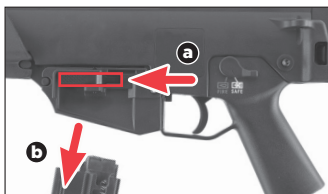

Press magazine release and remove empty magazine.

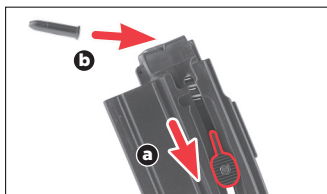

Use the side-mounted button to pull the follower down. Insert the cartridge under the magazine lips, pushing down the follower. Do not use excessive force.

## 2.2

## LOADING THE FIREARM



Insert the loaded magazine until the magazine catch locks it in position. After inserting a magazine, always test to make sure it is locked in place by giving it a firm tap on the bottom of the magazine.

## 2.3 LOADING THE CHAMBER WITH THE FIRST CARTRIDGE

**▲WARNING** Never put your hand in front of the muzzle.

**▲WARNING** Always load a round into the chamber by feeding it from the magazine. Failure to follow this warning can result in severe injury or death to you or others. Never attempt to load the firearm by inserting a round into the open ejection port.



Pick up the firearm with your shooting hand and point the muzzle in a safe direction. Use your other hand to retract and release the bolt with the help of the charging handle. Never put your hand in front of the muzzle. As the bolt travels forward, it feeds the first round into the chamber. The hammer is now cocked. Leave the safety in the safe position until you are ready to fire.



## 2.3 LOADING THE CHAMBER WITH THE FIRST CARTRIDGE

**⚠WARNING** G36 cal. .22 LR is designed so that it is able to fire when the magazine is removed. Therefore, if the magazine is removed from the firearm and there is a loaded round in the chamber, it will fire if the trigger is pulled. After inserting a magazine, always test to make sure it is locked in place by giving it a firm tap on the bottom of the magazine.

**⚠WARNING** Your firearm is now ready to fire. Keep your finger off the trigger and out of the trigger guard until you are ready to fire.

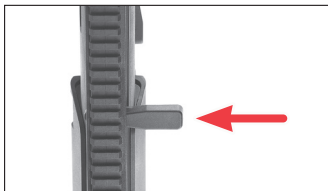
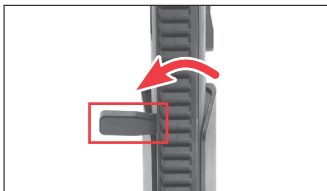

The charging handle can be used on both sides. Also it can be locked in place on either side, by turning it to the side and pushing it in.

## 2.4

## FIRING

Grab firearm with one hand on the forearm and other hand on the grip with index finger resting along outside of the trigger guard. Raise firearm and pull buttstock firmly into shoulder. Aim at a safe target. Push the manual safety to the fire position. Squeeze the trigger slowly and maintain the pressure until the round is fired. Your firearm loads another round immediately after firing.



- If you wish to stop, release trigger, remove finger from trigger guard, and set safety selector to “SAFE” position.
- If you have fired the last round from the magazine, the bolt will be held in the rearmost position so that the firearm can quickly be reloaded by replacing the magazine, or the chamber can be inspected to ensure it is empty.

**▲WARNING** Keep the firearm pointed in a safe direction when decocking. Failure to do this can result in serious injury or death.

- If you decide not to fire after the hammer has been cocked or if you decide to suspend firing, keep the firearm pointed in a safe direction.
- Remove your finger from within the trigger guard.
- Place the manual safety in the “SAFE” position and remove the magazine.
- Pull charging handle rearward to eject any remaining cartridge(s).
- Make sure that the firearm is unloaded (magazine removed, chamber cleared, empty chamber indicator (red tab) installed, and barrel clear of any obstructions)!
- You must be certain there is no cartridge in the chamber or obstructions in the barrel. Remember that any time you release the bolt while a magazine containing cartridges is in the firearm, you will have reloaded the firearm and it will be capable of firing.
- Place the manual safety in the “FIRE” position.
- Squeeze trigger to decock the firearm.
- Place manual safety in the “SAFE” position
- The firearm may now be transported safely.

**NOTICE** The gun has an internal bolt catch. To put the bolt into its forward position, first insert the empty chamber indicator (red tab), then retract the charging handle and release it.

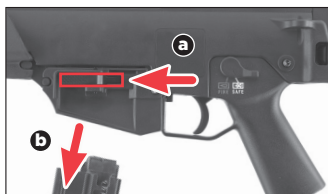

## 2.6

## MANUAL BOLT CATCH

To use the manual bolt catch, put the gun in "SAFE" and eject the magazine. Pull back the charging handle and at the same time press the manual bolt catch up. Release the charging handle, while still pressing the manual bolt catch and the bolt will stay open.

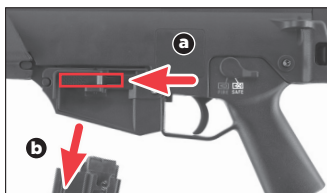

**If you encounter any problems in attempting to disassemble or assemble the G36 .22LR contact the Heckler & Koch Customer Service Department at 706-701-5554 or by email at [cs@heckler-koch-us.com](mailto:cs@heckler-koch-us.com).**

## 2.7

## FIREARM WITH EMPTY MAGAZINE

**NOTICE** After the last round has been fired, the bolt catch holds the bolt in the open position. Place the manual safety in the “SAFE” position.



### Continue shooting

Replace the empty magazine with a full one. Pull bolt rearward and release with the help of the charging handle. The bolt will travel forward and load the chamber with the first round. Keep your firearm in your shooting hand, finger off the trigger and the firearm pointed in a safe direction so that there is no danger to you or other persons.

### Discontinue shooting

Remove magazine and inspect the chamber to verify it does not contain any ammunition. Close the bolt and decock hammer as described in section 2.5.

## 2.8

## UNLOADING

Point the muzzle in a safe direction. Make sure the firearm is in on “SAFE”. Remove the magazine. Ensure that the chamber is empty by pulling back the charging handle to visually inspect the chamber. Place empty chamber indicator (red tab) into the empty chamber. Keep firearm pointed in a safe direction. Retract the charging handle and release, so that the bolt moves into battery. Push the manual safety to the “FIRE” position and squeeze trigger to decock the firearm. Push the manual safety to the “SAFE” position. The firearm may now be carried safely.

## 2.9

## CLEARING MISFIRE

**▲WARNING** If your firearm gives any indication that it is not performing properly or the operation of your firearm has changed “the way it feels or sounds”, stop firing. Make sure the firearm is pointed in a safe direction, unload the firearm and have it inspected and test fired by an HECKLER & KOCH qualified gunsmith.

- If a cartridge fails to fire, wait 30 seconds while keeping the muzzle pointed in a safe direction.
- Keep your finger off the trigger and out of the trigger guard.
- Place the manual safety in the “SAFE” position and remove the magazine.
- Grasp the bolt with the charging handle and briskly pull it fully rearward to eject the misfired round. Check the barrel chamber and bore visually for any obstructions. Never look down the barrel from the muzzle end.
- You must be certain there are no cartridges in the chamber or obstructions in the barrel. Remember that any time you release the bolt while a magazine containing cartridges is in the firearm, you will have reloaded the firearm and it will be capable of firing.

**NOTICE** In case of feeding failures, retract the charging handle to extract the damaged round.

**▲WARNING** Never try to use a misfired cartridge again.

## 3.1

## SETTINGS - REAR SIGHT

The dual aperture rear sight can be adjusted between a peep and notch aperture rear sight.

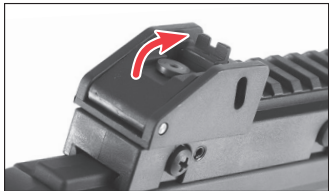
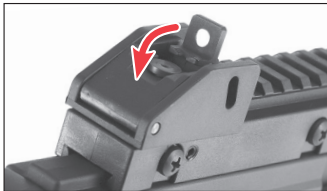

**Windage adjustment**

The windage is adjusted using the windage screw on the side of the rear sight. Turning the screw adjusts for windage left or right. Amount of adjustment is defined by a click when the screw is turned.

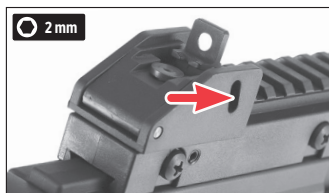
**Elevation adjustment**

The elevation is adjusted by turning the screw tighter or loosening it.

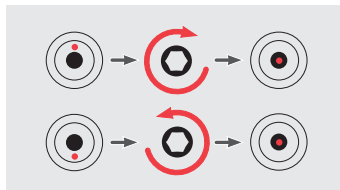
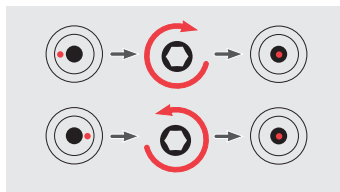
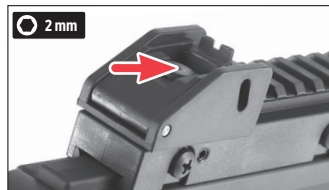

**Setting of the foldable stock (only rifle version)**

Pushing the buttstock latch allows the buttstock to be positioned in either an extended or closed position.

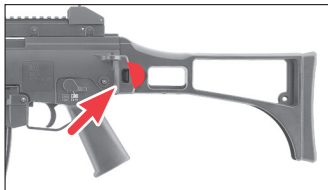
**Mounting an optical sight**

- The gun is equipped with a Picatinny rail following MIL-STD 1913.
- This rail allows the installation of various accessories, like aiming devices, laser sights, lights and others.
- Unscrew the screws of the clamping bars of the accessory.
- Place the accessory on the Picatinny rail and make sure it is in the correct position and securely attached to the rail. Finally, tighten the screws of the clamping bar.

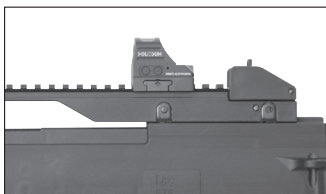
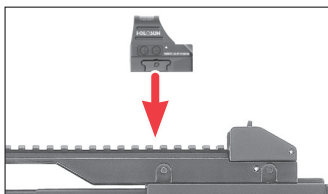

**▲WARNING** Always follow the disassembly instructions exactly. Never do anything beyond what you are specifically instructed to do in this manual. Never alter or modify the parts in your firearm. Always wear eye protection that is specified for use with firearms, every time you handle your firearm for cleaning and maintenance. Prior to disassembly, place the manual safety in the "SAFE" position, take out the magazine and check that the firearm is not loaded.

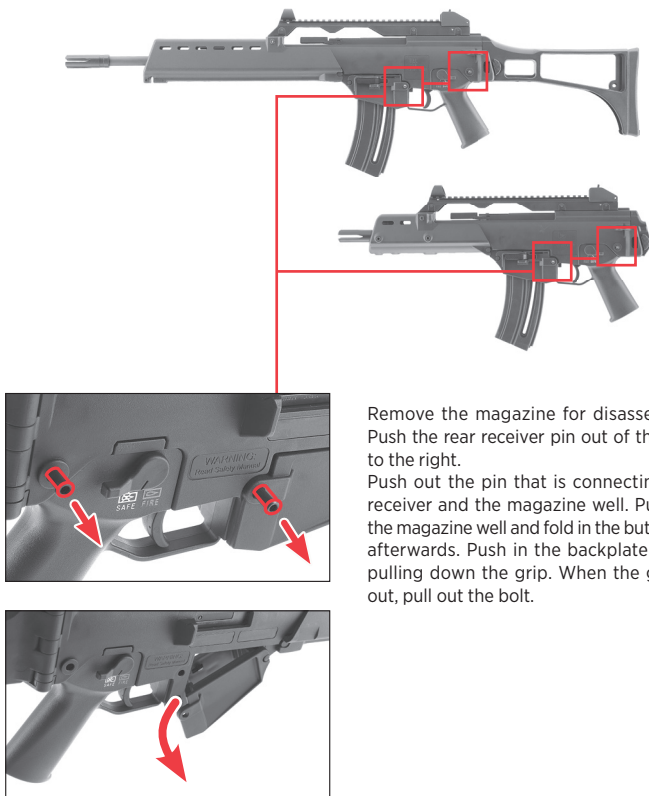

Remove the magazine for disassembly. Push the rear receiver pin out of the gun to the right. Push out the pin that is connecting the receiver and the magazine well. Pull out the magazine well and fold in the buttstock afterwards. Push in the backplate while pulling down the grip. When the grip is out, pull out the bolt.

## 5.1

## FIELD STRIPPING

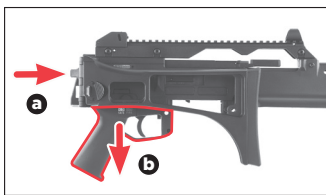
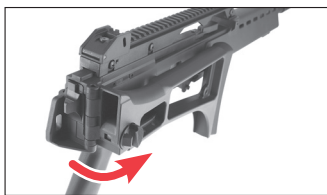

---

**NOTICE** Further disassembly is not necessary or recommended and will void your warranty.

---

If you encounter any problems in attempting to disassemble or assemble the G36 .22LR contact the Heckler & Koch Customer Service Department at 706-701-5554 or by email at [cs@heckler-koch-us.com](mailto:cs@heckler-koch-us.com).

## 5.2

## MAINTENANCE

In order to keep the firearm functional and to extend its service life, the firearm should be cleaned and maintained at regular intervals.

---

**WARNING** Before cleaning, make sure that the firearm is always pointed in a safe direction, is on "SAFE", and is unloaded (magazine removed, chamber cleared, and barrel clear of any obstructions).

---

## 5.2

## MAINTENANCE

- Verify gun is on “SAFE”.
- Insert EMPTY magazine and retract charging handle so that bolt assembly remains in open position.
- Remove magazine.
- Visually inspect to verify that no ammo remains anywhere in the firearm.
- Thoroughly clean the bolt assembly area with a brush and cloth (aerosol gun scrubber works great) to remove powder residue and debris.
- Remove fouling from breech, magazine lips, follower, and receiver with a brush and a cloth.
- Clean the barrel with bore solvent utilizing a flexible cleaning rod inserted through breech end of barrel (where bullet seats).

---

**NOTICE** Cleaning the barrel from the muzzle end requires a bore brush that does NOT exceed 1-inch in the length. Using a brush exceeding this length will result in the brush being lodged in the breech area.

---

- Reassemble firearm by installing the rear pin. Make sure it is in correct position.
- Wipe down exterior surface of firearm with gun oil.
- Pull and hold charging handle rearward, insert the empty chamber indicator (red tab), then release to close the bolt assembly.

## 5.3

## STORAGE

---

**▲WARNING** Never leave a loaded firearm unattended!

---

Always keep and store your firearm in an unloaded condition with the safety in the “SAFE” position. Keep the firearm and ammunition away from children and unauthorized persons. Firearms should be stored separately from ammunition. Always store your firearm with the empty chamber indicator (red tab) in the chamber to make sure no cartridge is loaded.



**WARRANTY REGISTRATION**

New HK firearms are covered by Heckler & Koch, Inc.'s Limited Lifetime Warranty.

Warranty registration is now online. To register your new HK firearm, go to:

<https://hk-usa.com/warranty/registration/>

If you do not have access to the Internet, contact Heckler & Koch, Inc. to obtain a warranty registration form:

HK Customer Service

5675 Transport Boulevard

Columbus, GA 31907

Telephone: 706-701-5554.

Email: [cs@heckler-koch-us.com](mailto:cs@heckler-koch-us.com)

**HECKLER & KOCH, INC. LIMITED LIFETIME WARRANTY**

All new Heckler & Koch, Inc. firearms purchased after January 1, 1998, are warranted to the original retail purchaser only for the lifetime of the said original retail purchaser. In the event that this original retail purchaser, at the time of the original purchase, shall donate this firearm to another person, the donee name must be submitted during the online warranty registration. Heckler & Koch, Inc. does not guarantee or warrant that any, all, or some donations or gifts are valid and compliant with all applicable laws, regulations, and ordinances. Heckler & Koch, Inc. is not responsible or liable in any way for a donation or gift that does not comply with applicable laws, regulations, and ordinances. It is the responsibility of the original retail purchaser and the donee or recipient to ensure that any such transfer complies with all applicable laws, regulations, and ordinances. Upon completion of the online warranty registration indicating the name of the said donee, this warranty shall be extended to the lifetime of the said donee. This warranty applies only if the firearm was imported into the United States and distributed by Heckler & Koch, Inc. to an authorized dealer.

**What Will We Do?**

Heckler & Koch Inc. will, at its option, repair or replace without charge any HK firearm that fails due to a defect in materials or workmanship. Parts and labor are included. Repairs are warranted for the duration of the warranty. If Heckler & Koch, Inc. replaces a firearm under this warranty; you will receive a new warranty. Heckler & Koch, Inc. will return your firearm to you shipping pre-paid.

**How to Obtain Service:**

Contact Heckler & Koch, Inc. via phone at 706-701-5554 or email at [cs@heckler-koch-us.com](mailto:cs@heckler-koch-us.com) for a Return Authorization Number before sending your firearm freight prepaid to Heckler & Koch, Inc. at the address listed below. No C.O.D. shipments will be accepted.

Only the existing Heckler & Koch, Inc. Service Center or any other authorized Heckler & Koch, Inc. Service Center that may be established by Heckler & Koch, Inc. shall be authorized to make warranty repairs.

Return the complete, unloaded firearm with a detailed description of the problem using Heckler & Koch, Inc.'s Return Form.

**DO NOT send any live ammunition with the firearm. If you must send ammunition to us for proof purposes, be sure that it is sent separately from the firearm.**

We strongly recommend that you complete the online warranty registration at <https://hk-usa.com/warranty/registration/> to establish eligibility for warranty service. If you do not return an acknowledgment of online warranty registration to Heckler & Koch, Inc., you are required to provide adequate proof of the date that you purchased your new HK firearm at the time you send your firearm to Heckler & Koch, Inc. for warranty service.

In the event that this firearm was given as a gift at the time of original purchase, the online warranty registration with the name of the donee must be provided to Heckler & Koch Inc., in order for the warranty to become effective.

Note: Non-warranty servicing must follow the same shipping procedures as stated above. HK firearms with a valid Return Authorization Number should be shipped to the following address in accordance with these instructions:

HKI

Attn: Service Department/RA# \_\_\_\_\_

5675 Transport Blvd.

Columbus, GA 31907

Any information gathered in connection with a Heckler & Koch Inc. lifetime limited warranty shall be used for that purpose and may be used for other legitimate business purposes of Heckler & Koch Inc. For further information, please review Heckler & Koch, Inc.'s Privacy Policy, located at <https://hk-usa.com/cookie-policy-us/>

### **What Is Not Covered?**

This warranty does not cover defects or damage caused by: (1) unreasonable use; (2) failure to provide proper care or maintenance; (3) failure to comply with instructions in the operator's manual including improper installation of original Heckler & Koch Inc. parts by the owner or his agent; (4) normal wear and tear for the degree of use; (5) rust or corrosion; (6) obstructions in the barrels; (7) excessive use; and/or (8) external and internal cosmetic finishes.

Heckler & Koch, Inc. reserves the right to determine what constitutes the unreasonable or excessive use of the firearm. All wooden parts and all accessories are excluded from warranty coverage.

This warranty does not cover any claims made by the second or subsequent owner of an HK firearm as stated above.

---

**NOTICE** Any unauthorized alteration or modification of the firearm or use of parts or components not originally made by Heckler & Koch, Inc. may void this warranty. Heckler & Koch, Inc. is not be responsible for any claims involving this firearm that result from the use of faulty, nonstandard, remanufactured, or reloaded ammunition or ammunition not manufactured to NATO, CIP, and/or SAMMI specifications.

---

Under no circumstances shall Heckler & Koch, Inc. be responsible or liable for incidental or consequential damages with respect to loss of use, loss of business or profits, other economic loss or injury to property, whether as a result of breach of express or implied warranty, negligence or otherwise. This Limited Lifetime Warranty applies only to retail purchases by individuals through an authorized Heckler & Koch, Inc. dealer.

**Residents of CALIFORNIA, CONNECTICUT, DISTRICT OF COLUMBIA, HAWAII, MARYLAND, MASSACHUSETTS, MICHIGAN, NEW JERSEY, NEW YORK, AND U.S. TERRITORIES.**

Any work involving replacement of the receiver of a firearm requires that the firearm be returned to a licensed firearms dealer. A current, signed copy of the dealer's FFL will be required. Please provide contact information for the chosen dealer, if applicable.

---

**NOTICE** Customers in restrictive capacity states: **DO NOT ship high capacity magazines to Heckler & Koch Inc. They cannot be returned.**

---

**Exclusions**

This lifetime warranty explicitly excludes firearms purchased by the United States military, government institutions or agencies of the United States or any of its constituent states and territories, law enforcement agencies of the United States or any of its constituent states and territories, and/or security organizations located within the United States or any of its constituent states and territories. Firearms purchased by these entities and organizations for duty issue to their personnel and/or employees are covered by a one-year limited warranty against material defects and workmanship or as agreed upon in a valid contract.

This lifetime warranty also excludes rimfire .22L R firearms, and all suppressors, which are covered by a one-year warranty.

Some states do not allow the exclusion or limitation of incidental or consequential damages, so the above limitations or exclusions may not apply to you. This warranty gives you specific legal rights, and you may also have other rights, which vary from state to state. This limited warranty is the only express warranty by Heckler & Koch Inc.

Heckler & Koch Inc. does not authorize any dealer or any other person to vary the terms of this warranty or make any other express warranties.

**Heckler & Koch, Inc. Lifetime Barrel Guarantee**

Heckler & Koch, Inc. guarantees the serviceability of the bore of the barrels of all MR A4 Series rifles and pistols for the lifetime of the original consumer purchaser for individual use. This guarantee is based on barrels meeting standards on accuracy, velocity, and useability across the entire life of the A4 system. If at any time an A4 barrel fails to meet these standards, Heckler & Koch, Inc. will replace the barrel.

**Where to Get Further Help**

If you have questions concerning this warranty, please contact Heckler & Koch, Inc.'s Customer Service Department at:

5675 Transport Blvd. Columbus, GA 31907

Telephone: 706-701-5554

Email: [cs@heckler-koch-us.com](mailto:cs@heckler-koch-us.com)

**6.1****TECHNICAL DATA**

	<b>G36 RIFLE</b>	<b>G36 PISTOL</b>
caliber	.22 L.R. HV	.22 L.R. HV
action	blowback	blowback
trigger	single stage trigger	single stage trigger
trigger pull	7 - 10 lbs (3175 g - 4536 g)	7 - 10 lbs (3175 g - 4536 g)
magazine capacity	10, 20, 30 rounds	10, 20, 30 rounds
dimensions (L/H/W)	37.8 / 8.5 / 2.6 inch (960 / 236 / 65 mm)	20.9 / 8.5 / 2.6 inch (532 / 236 / 65 mm)
barrel length	18.125 inch (460mm)	10.25 inch (260mm)
sight radius	10.3 inch (261mm)	10.3 inch (261mm)
height / width	0.5/0.255 inch	0.5/0.255 inch
of rear sight aperture	(12.5/6.5 mm)	(12.5/6.5 mm)
front sight width	0.07 inch (1,9 mm)	0.07 inch (1,9 mm)
weight w/out mag	5.29 lbs (2398 g)	3.65 lbs (1655 g)
magazine weight (empty)	6.7 ounce (191 g)	6.7 ounce (191 g)

**6.2****VARIANTS****G36 RIFLE**

- Polymer Receivers
- Foldable Buttstock
- Adjustable Rear Sight (Windage, Elevation)

**G36 PISTOL**

- Polymer Receivers
  - Pistol End Cap
- Adjustable Rear Sight (Windage, Elevation)



- 1** Muzzle
- 2** Front sight
- 3** Charging handle

- 4** Upper receiver
- 5** Magazine well
- 6** Magazine release

- 7** Trigger guard
- 8** Safety
- 9** Rear sight

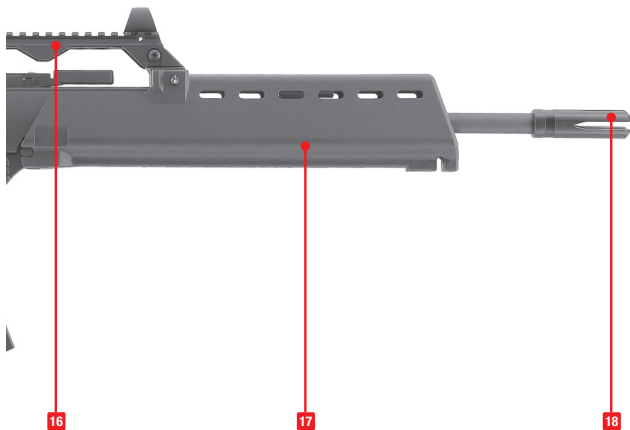
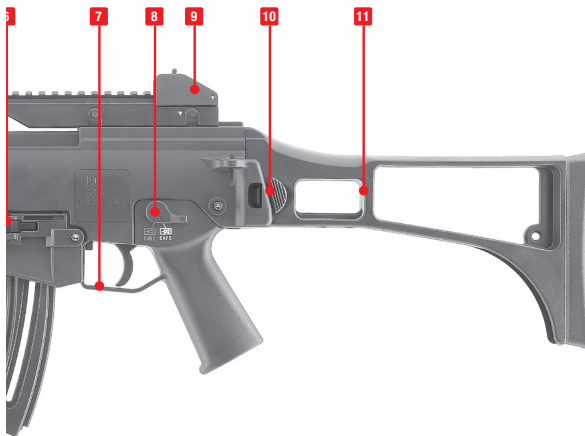

- 10** Buttstock lock
- 11** Folding stock
- 12** Grip

- 13** Trigger
- 14** Ejection port
- 15** Magazine

- 16** Picatinny rail
- 17** Handguard
- 18** Flash suppressor

1. The misuse of handguns is a leading contributor to juvenile violence and fatalities.
2. Safely storing and securing firearms away from children will help prevent the unlawful possession of handguns by juveniles, stop accidents, and save lives.
3. Federal law prohibits, except in certain limited circumstances, anyone under 18 years of age from knowingly possessing a handgun, or any person from selling, delivering, or otherwise transferring a handgun to a person under 18.
4. A knowing violation of the prohibition against selling, delivering, or otherwise transferring a handgun to a person under the age of 18 is, under certain circumstances, punishable by up to 10 years in prison.

#### FEDERAL LAW

The Gun Control Act of 1968, 18 U.S.C. Chapter 44, provides in pertinent part as follows:

#### 18 U.S.C. §922(x)

1. It shall be unlawful for any person to sell, deliver, or otherwise transfer to a person who the transferor knows or has reasonable cause to believe is a juvenile –
  - A. a handgun; or
  - B. ammunition that is suitable for use only in a handgun.
2. It shall be unlawful for any person who is a juvenile to knowingly possess –
  - A. a handgun; or
  - B. ammunition that is suitable for use only in a handgun.
3. This subsection does not apply to –
  - A. a temporary transfer of a handgun or ammunition to a juvenile or to the possession or use of a handgun or ammunition by a juvenile if the handgun and ammunition are possessed and used by the juvenile –
    - i. in the course of employment, in the course of ranching or farming related to activities at the residence of the juvenile (or on property used for ranching or farming at which the juvenile, with the permission of the property owner or lessee, is performing activities related to the operation of the farm or ranch), target practice, hunting, or a course of instruction in the safe and lawful use of a handgun;
    - ii. with the prior written consent of the juvenile's parent or guardian who is not prohibited by Federal, State, or local law from possessing a firearm, except –
      - I. during transportation by the juvenile of an unloaded handgun in a locked container directly from the place of transfer to a place at which an activity described in clause (i) is to take place and transportation by the juvenile of that handgun, unloaded and in a locked container, directly from the place at which such an activity took place to the transferor; or
      - II. with respect to ranching or farming activities as described in clause (i), a juvenile may possess and use a handgun or ammunition with the prior written approval of the juvenile's parent or legal guardian and at the direction of an adult who is not prohibited by Federal, State or local law from possessing a firearm;
    - iii. the juvenile has the prior written consent in the juvenile's possession at all times when a handgun is in the possession of the juvenile; and
    - iv. in accordance with State and local law;
  - B. a juvenile who is a member of the Armed Forces of the United States or the National Guard who possesses or is armed with a handgun in the line of duty;
  - C. a transfer by inheritance of title (but not possession) of a handgun or ammunition to a juvenile; or

- D. the possession of a handgun or ammunition by a juvenile taken in defense of the juvenile or other persons against an intruder into the residence of the juvenile or a residence in which the juvenile is an invited guest.
- 4. A handgun or ammunition, the possession of which is transferred to a juvenile in circumstances in which the transferor is not in violation of this subsection shall not be subject to permanent confiscation by the Government if its possession by the juvenile subsequently becomes unlawful because of the conduct of the juvenile, but shall be returned to the lawful owner when such handgun or ammunition is no longer required by the Government for the purposes of investigation or prosecution.
- 5. For purposes of this subsection, the term "juvenile" means a person who is less than 18 years of age.
- 6.
  - A. In a prosecution of a violation of this subsection, the court shall require the presence of a juvenile defendant's parent or legal guardian at all proceedings.
  - B. The court may use the contempt power to enforce subparagraph (A).
  - C. The court may excuse attendance of a parent or legal guardian of a juvenile defendant at a proceeding in a prosecution of a violation of this subsection for good cause shown.

## 18 U.S.C. § 924(a)(6)

- A.
  - i. A juvenile who violates section 922(x) shall be fined under this title, imprisoned not more than 1 year, or both, except that a juvenile described in clause (ii) shall be sentenced to probation on appropriate conditions and shall not be incarcerated unless the juvenile fails to comply with a condition of probation.
  - ii. A juvenile is described in this clause if -
    - I. the offense of which the juvenile is charged is possession of a handgun or ammunition in violation of section 922(x)(2); and
    - II. the juvenile has not been convicted in any court of an offense (including an offense under section 922(x) or a similar State law, but not including any other offense consisting of conduct that if engaged in by an adult would not constitute an offense) or adjudicated as a juvenile delinquent for conduct that if engaged in by an adult would constitute an offense.
- B. A person other than a juvenile who knowingly violates section 922(x) -
  - i. shall be fined under this title, imprisoned not more than 1 year, or both; and if the person sold, delivered, or otherwise transferred a handgun or ammunition to a juvenile knowing or having reasonable cause to know that the juvenile intended to carry or otherwise possess or discharge or otherwise use the handgun or ammunition in the commission of a crime of violence, shall be fined under this title, imprisoned not more than 10 years, or both.

Certain states have laws requiring that specific warnings be provided with handguns sold in those states as a result of which safety warnings are included in this manual.

**CALIFORNIA:** **WARNING**

"Firearms must be handled responsibly and securely stored to prevent access by children and other unauthorized users. California has strict laws pertaining to firearms, and you may be fined or imprisoned if you fail to comply with them. Visit the Web site of the California Attorney General at <https://oag.ca.gov/firearms> for information on firearm laws applicable to you and how you can comply. Prevent child access by always keeping guns locked away and unloaded when not in use. If you keep a loaded firearm where a child obtains and improperly uses it, you may be fined or sent to prison. If you or someone you know is contemplating suicide, please call the national suicide prevention lifeline at 1-800-273-TALK (8255)."

 **ADVERTENCIA**

"Las armas de fuego deben manipularse de manera responsable y segura para evitar el acceso de niños y otros usuarios no autorizados. California tiene leyes estrictas relacionadas con armas de fuego, y usted puede ser multado o encarcelado si no las cumple. Visite la página web del Procurador General de California en <https://oag.ca.gov/firearms> para obtener información sobre las leyes de armas de fuego que le son aplicables y cómo puede cumplirlas. Evite el acceso de niños manteniendo siempre las armas bloqueadas y descargadas cuando no estén en uso. Si mantiene un arma de fuego cargada donde un niño obtiene y la usa indebidamente, se le puede multar o enviar a prisión. Si usted o alguien que conoce está pensando en suicidarse, llame a la línea nacional de prevención del suicidio al 1-800-273-TALK (8255)."

**CONNECTICUT:**

"UNLAWFUL STORAGE OF A LOADED FIREARM MAY RESULT IN IMPRISONMENT OR FINE."

**FLORIDA:**

"IT IS UNLAWFUL, AND PUNISHABLE BY IMPRISONMENT AND FINE, FOR ANY ADULT TO STORE OR LEAVE A FIREARM IN ANY PLACE WITHIN THE REACH OR EASY ACCESS OF A MINOR UNDER 18 YEARS OF AGE OR TO KNOWINGLY SELL OR OTHERWISE TRANSFER OWNERSHIP OR POSSESSION OF A FIREARM TO A MINOR OR A PERSON OF UNSOUND MIND."

**MAINE:**

"ENDANGERING THE WELFARE OF A CHILD IS A CRIME. IF YOU LEAVE A FIREARM AND AMMUNITION WITHIN EASY ACCESS OF A CHILD, YOU MAY BE SUBJECT TO FINE, IMPRISONMENT OR BOTH. KEEP FIREARMS AND AMMUNITION SEPARATE. KEEP FIREARMS AND AMMUNITION LOCKED UP. USE TRIGGER LOCKS."

**MARYLAND:**

"WARNING: Children can operate firearms which may cause death or serious injury. It is a crime to store or leave a loaded firearm in any location where an individual knew or should have known that an unsupervised minor would gain access to the firearm. Store your firearm responsibly!"

**MASSACHUSETTS:**

"WARNING FROM THE MASSACHUSETTS ATTORNEY GENERAL: This handgun is not equipped with a device that fully blocks use by unauthorized users. More than 200,000 firearms like this one are stolen from their owners every year in the United States. In addition, there are more than a thousand suicides each year by younger children and teenagers who get access to firearms. Hundreds more die from accidental discharge. It is likely that many more children sustain serious wounds or inflict such wounds accidentally on others. In order to limit the chance of such misuse, it is imperative that you keep this weapon locked in a secure place and take other steps necessary to limit the possibility of theft or accident. Failure to take reasonable preventive steps may result in innocent lives being lost, and in some circumstances may result in your liability for these deaths."

"IT IS UNLAWFUL TO STORE OR KEEP A FIREARM, RIFLE, SHOTGUN OR MACHINE GUN IN ANY PLACE UNLESS THAT WEAPON IS EQUIPPED WITH A TAMPER-RESISTANT SAFETY DEVICE OR IS STORED OR KEPT IN A SECURELY LOCKED CONTAINER."

**NEW JERSEY:**

"IT IS A CRIMINAL OFFENSE, PUNISHABLE BY A FINE AND IMPRISONMENT, FOR AN ADULT TO LEAVE A LOADED FIREARM WITHIN EASY ACCESS OF A MINOR."

NEW YORK CITY, NY:

"THE USE OF A LOCKING DEVICE OR SAFETY LOCK IS ONLY ONE ASPECT OF RESPONSIBLE WEAPON STORAGE. ALL WEAPONS SHOULD BE STORED UNLOADED AND LOCKED IN A LOCATION THAT IS BOTH SEPARATE FROM THEIR AMMUNITION AND INACCESSIBLE TO CHILDREN AND ANY OTHER UNAUTHORIZED PERSONS. NEW YORK CITY LAW PROHIBITS, WITH CERTAIN EXCEPTIONS, ANY PERSON FROM ACQUIRING MORE THAN ONE FIREARM, OR MORE THAN ONE RIFLE OR SHOTGUN, WITHIN A 90-DAY PERIOD."

**NORTH CAROLINA:**

"IT IS UNLAWFUL TO STORE OR LEAVE A FIREARM THAT CAN BE DISCHARGED IN A MANNER THAT A REASONABLE PERSON SHOULD KNOW IS ACCESSIBLE TO A MINOR."

"Any person who resides in the same premises as a minor, owns or possesses a firearm, and stores or leaves the firearm (i) in a condition that the firearm can be discharged and (ii) in a manner that the person knew or should have known that an unsupervised minor would be able to gain access to the firearm, is guilty of a Class 1 misdemeanor if a minor gains access to the firearm without the lawful permission of the minor's parents or a person having charge of the minor and the minor:

- (1) Possesses it in violation of G.S. 14-269.2(b);
- (2) Exhibits it in a public place in a careless, angry, or threatening manner;
- (3) Causes personal injury or death with it not in self-defense; or
- (4) Uses it in the commission of a crime."

**TEXAS:**

"IT IS UNLAWFUL TO STORE, TRANSPORT, OR ABANDON AN UNSECURED FIREARM IN A PLACE WHERE CHILDREN ARE LIKELY TO BE AND CAN OBTAIN ACCESS TO THE FIREARM."

**WISCONSIN:**

"IF YOU LEAVE A LOADED FIREARM WITHIN THE REACH OR EASY ACCESS OF A CHILD YOU MAY BE FINED OR IMPRISONED OR BOTH IF THE CHILD IMPROPERLY DISCHARGES, POSSESSES OR EXHIBITS THE FIREARM."

State laws and regulations concerning firearms change constantly. Please check with your State Attorney General's Office or State Police for additional laws and regulations regarding the storage and use of firearms in your state.







8.573.90.04 rev. B © 06/2026

HECKLER & KOCH  
5675 Transport Boulevard  
Columbus, Georgia 31907  
Tel: 706-701-5554  
[www.hk-usa.com](http://www.hk-usa.com)

---

**⚠ WARNING** This product can expose you to chemicals including lead, which is known to the State of California to cause cancer and birth defects or other reproductive harm. For more information go to [www.P65Warnings.ca.gov](http://www.P65Warnings.ca.gov).