

USC OPERATOR'S MANUAL



HK[®]
HECKLER & KOCH

Covering all models of the
Universal Self-loading Carbine .45 ACP

SAFETY PRECAUTIONS

CAUTION: Read these safety rules before handling the carbine!

Read this operators manual before handling your firearm. The following safety rules are placed in this manual by HK as an important reminder that firearms safety is your responsibility. If handled improperly firearms can be dangerous and can potentially cause damage to property, serious injury, or death.

1. Never point a firearm at anyone, or in any direction other than a SAFE direction, i.e. downrange.
2. Treat all firearms as if they are always loaded.
3. Keep your finger off the trigger and outside of the trigger guard until your sights are aligned on the target.
4. Keep your finger off the trigger and outside of the trigger guard while loading or unloading the firearm.
5. Keep your finger off the trigger and outside of the trigger guard while pulling the firearm out of the holster or while returning it to the holster.
6. Be sure of your target and the back stop beyond.
7. Never give a firearm to or take a firearm from anyone unless the action is open and the magazine and/or chamber are free of any ammunition or brass.
8. Only use ammunition designed to SAAMI specifications that is factory-loaded, undamaged, and of the correct caliber. The use of low powered cartridges (including wadcutter and semi-wadcutters bullets) could lead to functional stoppages (including bullets stuck in the barrel) and is not recommended.
9. Before firing, remove the magazine from the firearm, lock the slide open, make sure the chamber is clear of any ammunition or brass, and check the barrel of the unloaded firearm for any possible obstructions.
10. Before firing any firearm that is unfamiliar to you, make sure that you understand exactly how it functions. A lack of familiarity with the firearm can result in serious accidents. Attend a certified training course on any firearm which you intend to use or with which you are not sufficiently familiar.
11. Always wear hearing and eye protection when using your firearm.
12. Keep all body parts, particularly the hands and fingers, away from the muzzle to avoid injury or burns.
13. Be sure that parts of the hand do not touch or interfere with the slide. The bolt moves backwards by recoil force during firing and may cause serious injury.
14. Firearms should be stored separately from ammunition and beyond the reach of children, and/or any untrained individuals.
15. Avoid the use of any alcoholic beverages or drugs before and during the use of any firearm.
16. Discharging firearms in poorly ventilated areas, cleaning firearms, or handling ammunition may result in exposure to lead, a substance known to be associated with birth defects, reproductive harm, and other serious injury. Have adequate ventilation at all times. Wash hands thoroughly after exposure.
17. To make the firearm safe, ensure the chambered round is removed during the clearing procedure. Removal of the magazine does not remove the chambered round. This can only be done with the rearward movement of the bolt after the magazine is removed.

STOP! KNOW HOW TO CLEAR THIS FIREARM BEFORE ATTEMPTING TO OPERATE.

CLEARING THE CARBINE

The carbine is not considered "clear" or safe unless:

1. The selector lever is on "safe" and;
2. The magazine is removed from the carbine and;
3. The bolt is locked to the rear and;
4. The chamber is free of brass or ammunition

To Clear the carbine:

1. Make sure fingers are outside of the trigger guard and the firearm is pointed in a safe direction at all times!
2. ON SAFE – Rotate the safety/selector lever to the "Safe" position, With the safety/selector lever reference line aligning with the SAFE position (white bullet symbol in rectangle superimposed with an "X" .
3. REMOVE MAGAZINE – depress the magazine release lever and remove the magazine from the firearm.
4. COCKING LEVER – Rotate the ejection port towards the ground and pull the cocking lever rearward one or more times to insure the chamber is empty. Watch for a live round or empty case to be ejected. Rotate the cocking lever upward slightly and lock it into the indent in the cocking lever housing to lock the bolt open.
5. INSPECT CHAMBER – Inspect the chamber for the presence of a live round or empty case by:
Visually – View chamber through open ejection port.
Physically – Insert index finger through magazine well or ejection port and feel for the presence of a round or cartridge case in the chamber.
Remove any live rounds or empty cartridge cases from the chamber or from within the firearm or magazine before handling the USC further.

The carbine is now considered "Clear."

CAUTION: Read the safety rules before handling the USC Carbine!

USC

Universal Self-loading Carbine Operator's Manual

.45 ACP



HECKLER & KOCH

© Heckler & Koch, Inc., Nov 2025

All rights reserved

HECKLER & KOCH

5675 Transport Boulevard

Columbus, Georgia 31907 USA

Tel: (706) 568-1906

Customer Service: (706) 701-5554

E-mail: cs@heckler-koch-us.com

Specifications and models subject to change without notice.

TABLE OF CONTENTS

Safety Rules on the Use of the HK USC.....	inside cover
General	5
Assembly Groups	6
Description of Assembly Groups	7
Assembly Group 1 Upper Receiver with Barrel.....	7
Assembly Group 2 Bolt Group	8
Assembly Group 3 Lower Receiver with Trigger Mechanism	9
Assembly Group 4 Buttstock with Pistol Grip.....	10
Assembly Group 5 Magazine	10
Accessories	11
Carrying Sling.....	11
Cleaning Kit.....	11
Mounting Rails for Aiming Devices according to MIL-STD-1913	11
Handling and Operation	12
Filling the Magazine	12
Emptying the Magazine	12
Insertion and Removal of the Magazine	12
Loading the USC.....	13
Storage of the USC	13
Disassembly.....	15
Safety Check.....	16
Disassembly into Assembly Groups	16
Disassembly and Assembly of the Bolt Group.....	17
Disassembly and Assembly of the Magazine	17
Reassembly of the USC	18
Function Check.....	19
Cleaning & Maintenance.....	20
Normal Cleaning	22
Major Cleaning	22
Operator Inspection	22
Lubrication.....	23
Ammunition.....	24
Stoppages	24
Carrying Sling	25
Troubleshooting Guide	26
Sights.....	28
Exploded Diagram and Parts List.....	30
Specifications	32
Firearms Service Record.....	33

GENERAL

The USC Carbine is a semi-automatic small arm designed and constructed according to the latest methods of advanced technology. The upper receiver, magazine, lower receiver, and buttstock are made of high strength polymer. The USC is a simple blowback operated weapon with a fixed barrel capable of semi-automatic fire.

The USC offers maximum safety and accuracy as it fires from the closed bolt position. The USC is easily disassembled into its main assembly groups for cleaning and care without the use of tools.

NOTE: Photographs throughout this manual show the USC carbine with the accessory Picatinny rail mounted on the top of the upper receiver. Photos include both the gray and black polymer models, operation and maintenance is the same for both models.

Other accessories may also be available, please contact HK for more information.



Fig. 1 USC (left side view)



Fig. 2 USC (right side view)

Assembly Groups

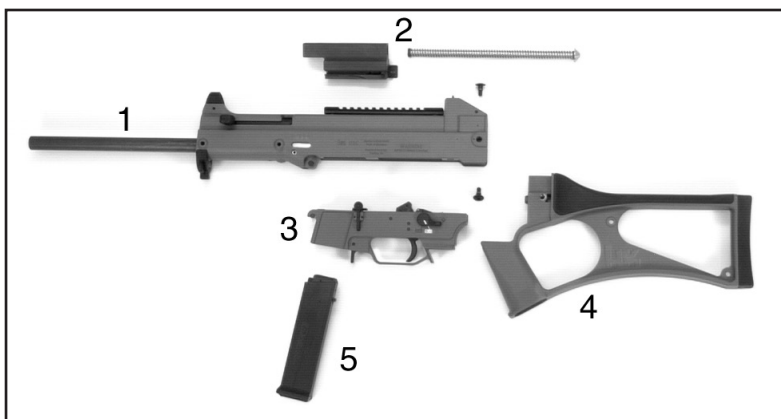

Fig. 4 USC Assembly Groups

1. Upper receiver with barrel, buttstock and attachment components
2. Bolt Group with recoil spring assembly, complete
3. Lower receiver with trigger mechanism, backplate and magazine well
4. Buttstock with pistol grip
5. Magazine

For accessories see page 11

DESCRIPTION OF ASSEMBLY GROUPS

Assembly Group 1 - Upper receiver with barrel

The upper receiver is produced using fiber-reinforced plastics and houses other subassemblies. The inside of the upper receiver contains metal guideways for the bolt group as well as attachment points for the lower receiver with magazine well and the buttstock.

The barrel is inserted into and pinned to the upper receiver. The cocking lever of the carbine is located above the barrel. It also serves to manually lock the bolt in its open position. The right side of the upper receiver contains the ejection port.

The bottom part of the upper receiver includes the support bolts for the lower receiver and a handstop with dual mounting points for the carrying sling.

The sights are fastened to the top of the upper receiver. They consist of a flip-up type rear sight with diopter (peep) and u-notch apertures as well as of the front sight post with front sight hood. A Picatinny rail is mounted on the top of the receiver. Six additional hard points are molded into the receiver on the left, right, and on the bottom sides. These hard points allow for the easy installation of additional rails.

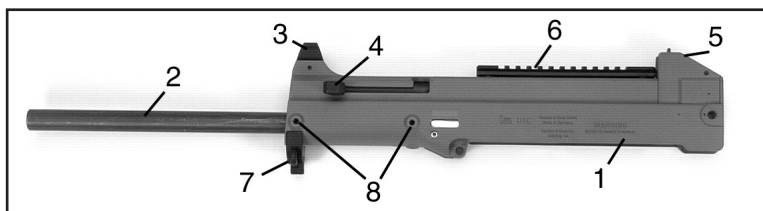

Fig. 5 Upper Receiver with barrel and attachment components

- | | |
|-------------------|-----------------------------|
| 1. Upper receiver | 5. Flip-up rear sight |
| 2. Barrel | 6. Accessory Picatinny rail |
| 3. Front sight | 7. Handstop |
| 4. Cocking lever | 8. Hardpoints |

Assembly Group 2 - Bolt Group

The bolt group, together with the recoil spring assembly, is contained inside the upper receiver. The reciprocal movement of the bolt group provides for feeding and ignition of the cartridge, for extraction and ejection of the spent case as well as for cocking of the hammer. The right side of the bolt has a thumb recess for manual closing of the bolt (forward assist).

The recoil spring assembly pushes the bolt forward into the firing position. The cone-shaped support for the recoil spring assembly is housed in the backplate of the lower receiver. The longitudinally movable guide ring supports itself within the bolt.

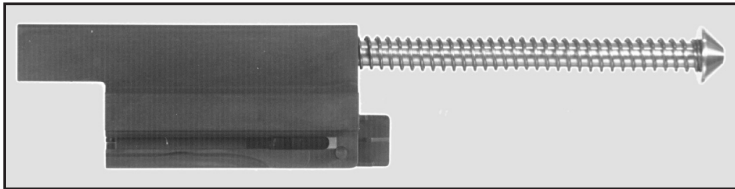

Fig. 6 Bolt Group, assembled

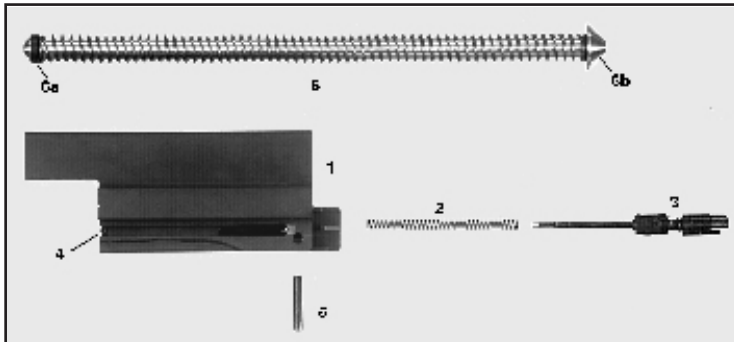

Fig. 7 Bolt Group, disassembled

The bolt group (Fig. 6 and 7) consists of:

- | | |
|------------------------|-------------------------------------|
| 1. bolt | 5. firing pin retaining pin |
| 2. firing pin spring | 6. recoil spring assembly, complete |
| 3. firing pin assembly | 6.a guide ring |
| 4. extractor | 6.b support |

Assembly Group 3 - Lower receiver with trigger mechanism

The lower receiver houses the trigger mechanism with ambidextrous safety/selector levers, the magazine well, magazine release lever and bolt catch. The forward portion of the lower receiver is hooked to the upper receiver. The rear portion is fastened to the upper receiver using guide rails in the pistol grip of the buttstock.

The safety/selector levers are fitted on both sides of the pistol grip. The forward portion of the lower receiver has lugs for attachment to the upper receiver. Behind these lugs is the magazine well with the magazine release lever.

Above the magazine release lever is the bolt catch. It serves to hold the bolt rearward when the last round is fired and to release the bolt from the open position after an empty magazine has been replaced with a loaded magazine. The rear side of the lower receiver includes the integrated backplate with buffer and support for the recoil spring assembly.

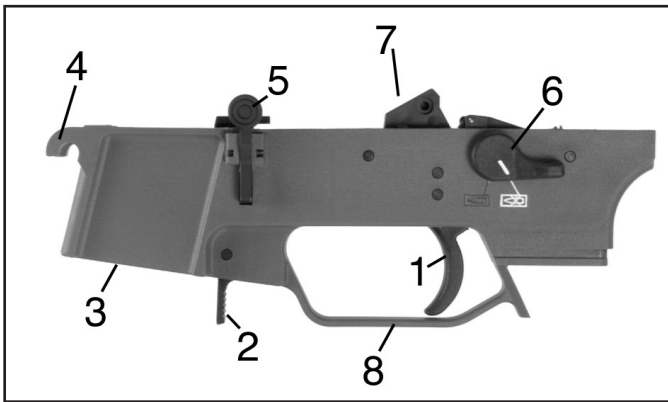

Fig. 8 Lower receiver with trigger mechanism and magazine well

- | | |
|---------------------------|--------------------------|
| 1. Trigger | 5. Bolt catch |
| 2. Magazine release lever | 6. Safety/Selector lever |
| 3. Magazine well | 7. Hammer |
| 4. Attachment lugs | 8. Trigger guard |

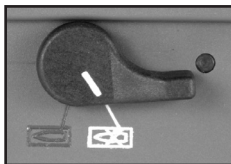

Fig. 9 safe

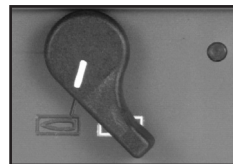



Fig. 10 semi-automatic fire

The safety/selector lever of the USC trigger mechanism has two positions :

Position  = Safe

Position  = Semi Automatic fire

Assembly Group 4 - Buttstock with pistol grip

The buttstock is attached to the receiver by the means of two hex head screws which can be installed or removed by using the HK tool.

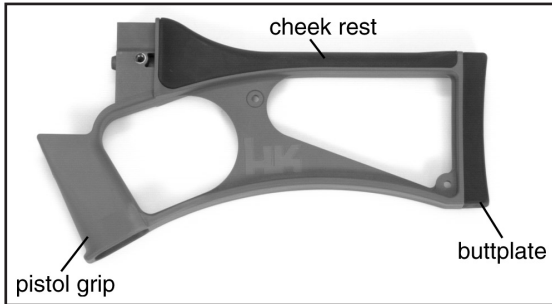

Fig. 11 Buttstock with pistol grip

The buttstock holds the upper and lower receiver together. A rubber cheek rest and buttplate are molded onto the polymer frame of the buttstock.

Assembly Group 5 - Magazine

The magazine housing is constructed from plastic. The magazine consists of: magazine housing, magazine floorplate, follower, follower spring and locking plate.



Fig. 12 Magazine, complete

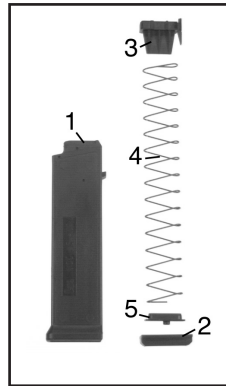

Fig. 13 Magazine, disassembled

1. Magazine housing
2. Magazine floorplate
3. Follower

4. Follower spring
5. Locking plate

ACCESSORIES

Carrying Sling

The carrying sling (Fig.14) enables the shooter to carry the USC carbine securely in a wide variety of positions.

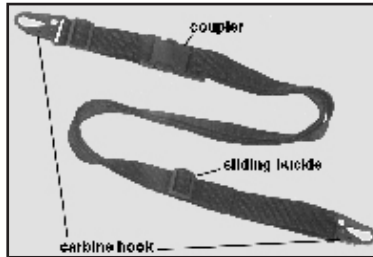

Fig. 14 Sling

Cleaning Kit - The cleaning kit includes:

1. Transport case
2. Cleaning patches
3. Cleaning brush
4. Cleaning rod with folding handle
5. Oil bottle
6. Bore brush
7. Patch holder

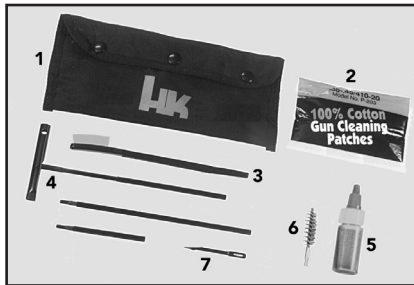

Fig. 15 Cleaning Kit

Mounting rails (MIL-STD-1913) for aiming devices

The mounting rail (Picatinny Rail) is screwed onto the molded-in hard points provided either on top of the receiver, below the forearm or on the right or left sides of the forearm.



Fig. 16 Mounting rails

HANDLING & OPERATION

Filling the Magazine

- Grasp magazine.
- Slide individual cartridges under the magazine lips one by one (Fig. 17).
- Repeat this process until the required number of cartridges has been inserted or the magazine is full (maximum 10 rounds).

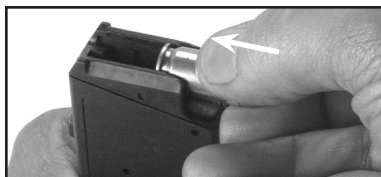

Fig. 17 Filling the magazine

NOTE: Loading more than the prescribed number of rounds will prevent the magazine from being inserted in the weapon with the bolt forward.

Emptying the Magazine

- Grasp magazine.
- With your thumb, push cartridges forward out of the magazine into the palm of the other hand **OR**
- Grasp magazine and hold it with the points of the bullets pointing towards the bottom.
- Use a piece of wood to slide the cartridges out of the magazine.

Insertion and Removal of Magazine

- Put the USC safety/selector on  (Safe).
- Insert magazine into the magazine well (Fig. 18). The magazine catch has to engage audibly in the process. Tug on the magazine to ensure it is fully engaged.
- For removal of the magazine, push magazine catch forward (Fig. 19) and remove magazine downward.



Fig. 18 Insert magazine



Fig. 19 Remove magazine

Loading the USC

Starting Situation 1: No magazine is present in the carbine. The bolt is forward.

- Put the USC safety/selector on  (Safe).
- Insert the loaded magazine into the magazine well until the magazine catch engages audibly. Tug downward to ensure it is properly seated.
- The USC is partially loaded with the safety on.
- Pull cocking lever backwards as far as it will go and let the bolt snap back to its forward position chambering a round. In the process do not ride the cocking lever forward.

WARNING: The USC is now fully loaded and with the safety on.

or

- Pull cocking lever backwards as far as it will go, (Fig. 20) and swivel it upwards (engage it in the indent) into the open position.
- Insert the loaded magazine into the magazine well until the magazine catch engages audibly. Tug to check.
- With the open palm of the non-firing hand "slap" the cocking lever downward and forward to chamber a round. During this process do not ride the cocking lever forward.

WARNING: The USC is now fully loaded with the safety on.



Fig. 20 Pull cocking lever backwards

Starting Situation 2: There is an empty magazine in the carbine. The bolt is held back by the bolt catch.

- Put the USC safety/selector on  (Safe).
- Push magazine catch forward and remove empty magazine.
- Insert the filled magazine into the magazine well until the magazine catch engages audibly. Tug to check.
- Depress upper end of bolt catch (Fig. 21), thus releasing the bolt and allowing it to snap forward chambering a round.

WARNING: The USC is now fully loaded with the safety on.



Fig. 21 Depress bolt catch to release the bolt

With heavy external fouling of the USC, (sand, sludge) or to load the firearm quietly, the thumb recess on the bolt may be used as a forward assist (Fig 25A). To do so use the thumb recess, push bolt forward until it is in the most forward position.



Fig. 22 Forward Assist

USC Storage

1. Store the carbine clean and lubricated.
2. Store the carbine without a round in the chamber.
3. Store the carbine with the cocking lever forward and the hammer down (at rest).
4. After no more than twelve (12) months unload all loaded magazines and replace the ammunition with fresh ammunition.
5. Clean and lubricate the carbine and magazines every twelve (12) months while in storage.
6. Store the carbine in a clean, dry environment with regulated temperature controls.

DISASSEMBLY

NOTE: The USC is easily disassembled and reassembled with the HK Tool. Do not use force in any of the disassembly procedures. Disassembly beyond the procedures outlined in this manual is not recommended and may void the HK Warranty. Disassembly beyond the operators level described here may be carried out by qualified maintenance personnel only. Contact HK for more information.

Safety Check

Clear the carbine! Before handling the firearm, "clear it!" Do so by:

1. Make sure fingers are outside of the trigger guard and the weapon is pointed in a safe direction at all times!
2. ON SAFE – Rotate the safety/selector lever to the "Safe" position. (With the safety/selector lever set at the white box with a white bullet symbol inside.)
3. REMOVE MAGAZINE – Depress the magazine release lever and remove the magazine from the magazine well.
4. COCKING LEVER – Rotate the ejection port toward the ground and pull the cocking lever rearward one or more times to insure the chamber is empty. Watch for a live round or empty case to be ejected. Rotate the cocking lever upward slightly and lock it into the indent in the cocking lever housing to lock the bolt open.
5. INSPECT CHAMBER – Inspect chamber for the presence of a live round or empty case. Visually – View chamber through open ejection port. Physically – Insert index finger through magazine well or ejection port and feel for the presence of a round or cartridge case in the chamber. Remove any live rounds or empty cases from the chamber or from within the firearm or magazine before handling the USC further.

The HK USC is now considered "Clear." Once clear, let the bolt move forwards.

Stripping into assembly groups

1. Detach carrying sling
2. Use the 5 mm Allen wrench of the HK tool and remove the hex headed Allen screws located on the left and right sides at the rear end of the receiver
3. Pull the buttstock straight back out of the guiding rails of the lower the receiver.
4. Swivel the lower receiver downward at an angle of approximately 45° and detach it from the support bolts of the upper receiver (figures 23 & 24).



Fig. 23 Detaching lower receiver



Fig. 24 (Detail) lower receiver

5. Pull back the cocking lever and remove the recoil spring assembly and the bolt to the rear (figure 25).

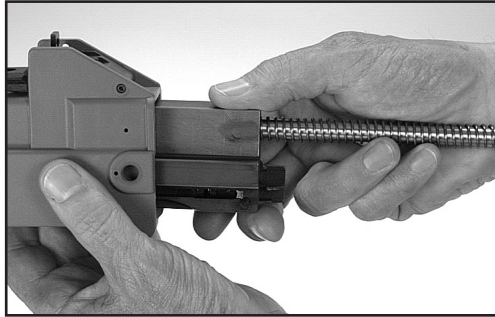

Fig. 25 Removing recoil spring

Disassembly of the Bolt

1. Push and hold firing pin forward.
2. Pull out firing pin assembly retaining pin to the left (Fig. 26).
3. Remove firing pin assembly and firing pin spring to the rear. To do this, push the locking catch to the right (Fig. 27). Prevent the firing pin assembly with firing pin spring from springing out with your thumb.

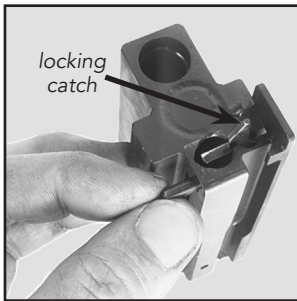

Fig. 26

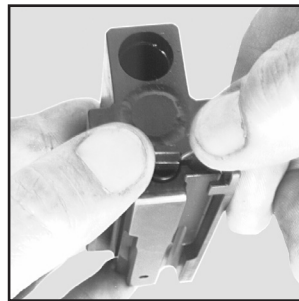

Fig. 27

Pull out firing pin retaining pin Push locking catch to the right

WARNING: Never disassemble the firing pin. Assembling the firing pin assembly incorrectly will disable the USC firing pin safety.

Assembly of the Bolt

1. Place firing pin spring onto firing pin.
2. Insert firing pin spring and firing pin assembly into the bolt from the rear and push them forward (Fig. 28).
3. Using any pointed object and push the rear end of the firing pin forward (Fig. 29).
4. Insert firing pin retaining pin from the left to retain firing pin assembly in the bolt.

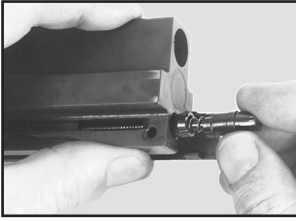

Fig. 28 Insert firing pin spring and firing pin assembly

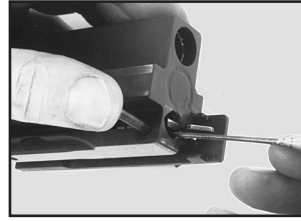

Fig. 29 Push firing pin forward

Disassembly of the Magazine

1. Depress locking plate through magazine floorplate and slide magazine floorplate to the rear (Fig. 30).
2. Detach magazine floorplate to the rear.
3. Remove follower spring with locking plate and follower.

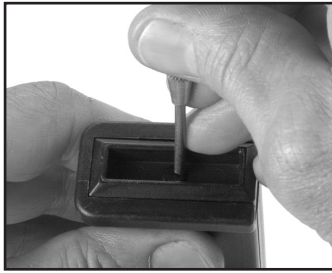

Fig. 30

CAUTION: Magazine floorplate is under spring tension. With your thumb secure locking plate with follower spring to prevent it from springing out.

Assembly of Magazine

1. Insert follower and follower spring with locking plate into the magazine housing from below.
2. Fully depress follower spring and locking plate (Fig. 31) and slide magazine floorplate onto magazine housing from the rear.
3. Push magazine floorplate forward as far as it will go.
4. Check that the floorplate is fully seated and secured in place by the tab of the locking plate.

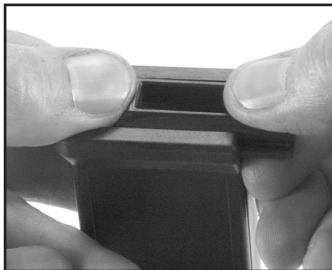

Fig. 31

Reassembly of the USC

1. With the cocking lever forward, insert the bolt and recoil spring assembly to the receiver from the rear.
2. From below, engage lower receiver (hammer between cocked and released positions) into the support bolts on the upper receiver and swivel it upward (Fig. 32).

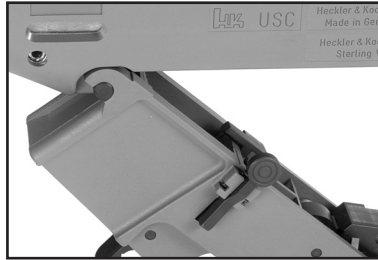

Fig. 32

3. Hold the upper and lower receiver firmly together. Slide buttstock guiding rails horizontally into the appropriate slots of the lower receiver (Fig. 33).



Fig. 33

Pushing buttstock into upper and lower receiver

4. Fasten the buttstock to the upper receiver by means of the two Allen screws with the HK tool (do not use excessive force to tighten the screws down).
5. Put the USC safety/selector on  (Safe).
6. Insert empty magazine.
7. Carry out a function check as described on page 19.
8. Attach carrying sling (Fig. 34)



Fig. 34

Attaching carrying sling

FUNCTION CHECK

NOTE: A Function Check should be performed anytime the carbine is reassembled. This quick check indicates whether or not the carbine has been properly assembled and/or assembled with all components. A properly executed Function Check can also reveal many of the more obvious malfunctions that could occur between the interactive components of the carbine. ALWAYS clear the carbine before performing the Function Check! ENSURE the carbine is clear! Be sure no ammunition is in or around the carbine!

1. **Clear the carbine!**
2. Place the cocking lever and bolt group in the forward position.
3. With the carbine on "Safe", pull the trigger. The hammer should not fall.
4. Place the weapon on "Semi-automatic". Pull the trigger and hold the trigger back. Hammer should fall.
5. Still holding the trigger back, recock the carbine. Release the trigger. Listen for the "click" of the trigger and sear resetting. Pull the trigger. The hammer should fall.
6. The Function Check is now complete.

CLEANING & MAINTENANCE

Operator Cleaning

- The functional performance of any mechanical device varies greatly on the quality and frequency of the maintenance performed on that item. Firearms are no exception. The operator spends most of the time with the weapon and therefore has the best opportunity to perform the necessary upkeep required to insure top performance at all times.
- Metal components of new USC are coated in a thick, oily preservative that should be removed prior to the weapon being used or fired. This preservative oil, applied by HK personnel prior to the shipment of the weapons from the manufacturing facility in Germany, guarantees that the weapons and accessories will remain corrosion-free during storage and transport. However, this preservative fluid is not considered a lubricant and therefore should be removed and replaced with a high-quality weapons lubricant whenever possible. This preservative fluid attracts debris and dirt and possesses little or no lubrication qualities.
- Cleaning the USC, especially with its polymer construction, need not take hours and a great deal of effort. With the right equipment a very fouled USC should be able to be thoroughly cleaned in less than 10 minutes. A solvent tank where the parts can be immersed in and scrubbed will save a great deal of time and effort as will compressed air to blow off the fouling and solvent or to spread the lubricant.

NOTE: If using ultra sonic cleaning machines, do not immerse the painted portion of the USC, specifically the color pictogram firing mode markings on the lower receiver. Ultra sonic cleaning or strong solvents will remove the markings!

- If such a set up is not available to you, a complete weapons cleaning kit specially designed for the HK USC will reduce your cleaning time and make the job easier.
- Any quality weapons solvent or oil can be used to clean the USC. Basically, if it's safe to put your bare hands into it won't hurt the surfaces of the weapon.
- At HK we recommend two types of operator cleaning. Normal cleaning and Major cleaning.

Normal cleaning

Performed after each firing or every twelve (12) months.

Major cleaning

Often referred to as "detailed cleaning". Performed on a USC after 1,000 rounds or when the weapon is exposed to or excessively laden with sand, dust, water or other visible contaminants or foreign matter.

- The cleaning intervals listed here are recommendations only!
- Your intervals between cleaning will vary greatly depending on many factors to include the type of ammunition used, the environment in which the weapon is used, and the thoroughness of your cleaning, etc.

Normal cleaning

1. **CLEAR THE CARBINE!**
2. Disassemble the weapon into the major assembly groups.

Multi-purpose carrying sling: The nylon webbing and plastic components of the multi-purpose carrying sling can be cleaned using warm water and a soft bristled brush. Allow the sling material to dry completely before storage or use. Avoid getting the metal sling components wet.

Buttstock: Simply remove any foreign debris from the exterior polymer and rubber surface of the buttstock using a toothbrush, rag, swabs or compressed air when available.

Lower receiver: Remove any foreign debris from the plastic pistol grip using a tooth-brush, rag, swabs or compressed air. Scrub the top of the hammer, ejector and the area around the front of the ejector with a small amount of solvent or oil to break up the carbon fouling. Remove the loose fouling and debris by rinsing the components in the a solvent tank or by using rags, swabs, or compressed air.

Forearm / foregrip: Remove any foreign debris from the forearm or optional foregrip using a toothbrush, rag or compressed air.

Upper receiver with barrel: Start with the bore and chamber.

- **Bore** – Apply a liberal amount of solvent to a bronze bristle bore brush of the appropriate caliber. Always insert the bore brush from the chamber end and push it all the way through the barrel in the direction that the bullet travels. Pull the brush back through the barrel. **DO NOT** use stainless steel brushes as they will damage the USC's rifling. **DO NOT** allow the brush to stop in the bore or it may get stuck! Repeat this in/out procedure for a minimum of three complete trips. Remove the bore brush and let the solvent work in the bore for a few minutes while you clean other components.
- **Chamber** – Apply a liberal amount of solvent to the appropriate bore brush. Insert the brush through the back of the receiver into the chamber. **DO NOT** push the brush past the chamber! Work the brush back and forth in the chamber at least three times. Remove the brush and let the solvent go to work on the fouling for a few minutes while you work on other components.
- **Chamber face** – This area is easily tackled using the special Chamber Face brush available in the HK Field Cleaning Kit for the USC carbine. Attach this brush to the cleaning rod and lock the handle so that the rod and brush can be turned together. Apply a liberal amount of solvent to the bristles of the brush. Insert the brush through the back of the receiver until it makes contact with the area surrounding the opening to the chamber and bore. With slight inward pressure, rotate the brush in a clockwise direction to break up the carbon fouling built-up on the face of the chamber. Continue this procedure until you are satisfied with your efforts.
- **Upper Receiver** – Apply a few drops of solvent to a toothbrush and scrub the area around the chamber face and along the length of the receiver rails to break-up the carbon fouling. Remove all of the fouling, carbon, and visible debris from the entire upper receiver using a solvent tank and compressed air or swabs, patches, rags, etc. Run at least three clean patches of the appropriate size all the way through the bore in the direction of bullet travel to remove the loose fouling and solvent.
- **Muzzle** – Use a nylon bristle toothbrush and a small amount of solvent to remove any fouling from the muzzle.

Bolt group: Scrub all parts of the bolt group with a toothbrush and solvent where carbon is visible, especially around the face of the bolt and the extractor. **Do not attempt to remove the extractor for cleaning!** There is no functional need to remove the extractor for normal cleaning. Remove the loose fouling from all parts using a rag, swabs or compressed air.

Magazine: Don't forget the magazines! Many stoppages occur as a result of improperly maintained magazines. Apply a few drops of solvent to a toothbrush and scrub the top of the magazine to remove any visible carbon fouling or loose debris. Pay special attention to the front edge of the housing, feed lips, and the follower. Remove the solvent and loose fouling from the magazine using a rag, swabs or compressed air.

Major Cleaning

As mentioned earlier, Major cleaning should be performed after 1,000 rounds are fired through a USC. Major cleaning is also performed when the weapon has been immersed in water or is laden with large amounts of visible foreign matter or fouling.

During major cleaning, all firearm components except the painted surfaces (firing modes symbols) and the carrying sling, should be rinsed with or immersed in solvent and scrubbed thoroughly with a brush. This includes the magazine and its parts. The components can then be dried using a rag or swabs, though compressed air is preferable for Major cleaning.

If any assembly groups require a more thorough cleaning, an "ultra-sonic" cleaning machine can be used containing any solvent that it is safe to place your bare hands in, as a general rule.

However, avoid placing painted surfaces such as the firing mode markings on the lower receiver into an ultra-sonic cleaner, as this may remove the colored markings. Further disassembly of any assembly group(s) beyond the level described above **must be performed by, or at a minimum supervised by, an HK factory-trained armorer.**

Operator inspection

During or after cleaning the operator should inspect the firearm and its components for any irregularities that may cause problems during its operation. If any potential deficiencies are noted, they should be corrected immediately and/or brought to the attention of the unit armorer. In general, the operator should keep a watchful eye out for the following discrepancies both in the weapon as a whole and in each assembly group.

- Improper function
- Missing parts
- Cosmetic flaws (cracks, dents, burrs, rust, etc.)
- Improper assembly
- Loss of spring tension (where applicable)
- Unusual looseness (where applicable)
- Cracked welds
- Excessive wear
- Absence of protective finish (where applicable)
- Absence of proper lubrication

Also check these areas more often if problems develop in USC operation.

LUBRICATION

Any type of high-quality, medium-weight lubricant (oil) specifically designed for use on firearms will work well on the HK USC carbine.

DO NOT use lubricants/cleaners that boast of their ability to penetrate metal as these substances may deaden primers.

Where and how much?

No Lube – (surface is dry and not slippery to the touch)

- Sling material
- Plastic components

Light Lube – (finger run across surface yields little or no lube)

- Bore and chamber
- All metal parts (except sound suppressor)
- Muzzle
- Magazine spring
- Axles of all operating controls (cocking lever, bolt catch, safety/selector lever, magazine catch, etc.)
- Rear sight assembly
- All metal accessories

Medium Lube – (finger run across surface yields some lube but lube does not run down surface when held in a vertical position)

- Bolt group with recoil spring and guide rod

Heavy Lube – (Lube runs down surface when held in a vertical position) *No heavy lube is required on the HK USC!*

- Reapply lubrication to the bolt of the USC periodically during firing as it burns off from the heat.
- Apply lubricant using a shaving brush, swabs, patches, or rag. A spray bottle also works well using compressed air to circulate the lubricant into all parts and to remove the excess lubricant.

AMMUNITION

The USC carbine was designed to use ammunition made to NATO or SAAMI specifications. Like an automobile engine, you cannot expect top performance by using poor quality fuel. The same applies to firearms. There are a number of general considerations that should be made when choosing the type of ammunition you plan to use in the USC.

DO USE

- Ammunition of the appropriate caliber and of recent manufacture
- Clean burning ammunition
- Non-corrosive ammunition
- Jacketed Hollow Point (JHP), ball, truncated cone, +P, etc.

DO NOT USE

- Reloads or remanufactured ammunition. Beware of military surplus, foreign or outdated ammunition.
- Non-jacketed or exposed lead ammunition
- Corrosive ammunition (primer and/or propellant)
- Empty cases as “dummy” (inert) rounds, as damage may result to the weapon, especially the synthetic magazines employed in the USC. Use complete dummy rounds available for training purposes.
- Any ammunition that exceeds NATO or S.A.A.M.I. pressure limits

WARNING: Only use ammunition designed to SAAMI specifications that is factory-loaded, undamaged, and of the correct caliber. The use of low powered cartridges (including wadcutter and semi-wadcutters bullets) could lead to functional stoppages (including bullets stuck in the barrel) and is not recommended.

Stoppages

In the event of stoppages on the USC, the carbine is to be considered loaded until the actual cause of the stoppage has been determined.

During the elimination of stoppages, all safety precautions are to be taken into account.

In the event of stoppages on the USC, for example the cartridge fired from the USC is not ignited, the bolt assembly does not close completely, or the spent cartridge case is not ejected, the following immediate steps must be taken:

1. Put the USC safety/selector on  (Safe).
2. Remove the magazine.
3. Pull rearward on the cocking lever and lock the bolt open.
4. Ensure that barrel, cartridge chamber and receiver are free of obstructions.
5. Next, determine and eliminate the cause of the stoppage. The items indicated in the following tables do not cover all possible stoppage situations.

CARRYING SLING

The carrying sling enables the USC to be carried in several ways. The carrying sling is attached to the mounting points on the receiver, handstop, or buttstock via the carbine hooks.

Length Adjustment

1. Close the coupler.
2. Rest the carrying sling between thumb and index finger and let the USC hang down in a horizontal position. Adjust the length in such a way that there is a space of approximately 10 cm (4 inches) between your forearm and the USC.

For adjustment

1. Slide the forward buckle and coupler with the sewn-up end as far as possible up to the front carbine.
2. Somewhat loosen the belt loop in the rear buckle.
3. To shorten the carrying sling, pull the upper loop forward.
4. To lengthen the carrying sling, pull the upper loop to the rear.
5. Tighten loop in the buckle.
6. Tighten carrying sling.

Routing the Carrying sling

In order to carry the USC laterally against the body or in front of the body (ready position), or on the back, the carrying sling must be properly routed. To do so:

1. Pull the two halves of the carrying sling apart and upward.
2. Place the upper part of the carrying sling onto your shoulder over your head.

TROUBLESHOOTING

Stoppage	Cause	Remedy
No cartridge fed by bolt.	<p>Magazine not properly inserted</p> <p>Magazine loose</p> <p>Follower spring lame</p> <p>Magazine lips damaged</p>	<p>Insert magazine properly</p> <p>Check magazine catch and tab on magazine. If required take USC to maintenance shop.</p> <p>Replace magazine or follower spring and take to maintenance shop.</p> <p>Replace magazine or magazine housing and take the damaged one to maintenance shop</p>
Bolt not fully closed. Cartridge not fully fed	<p>Cartridge chamber dirty</p> <p>Cartridge damaged</p> <p>Recoil spring lame</p> <p>Improperly cocked</p>	<p>Clean cartridge chamber</p> <p>Replace cartridge</p> <p>Take USC to maintenance shop</p> <p>Allow cocking lever to snap forward. On releasing cocking lever do not ride it forward.</p>
Bolt does not stay open after last shot	<p>Magazine spring lame</p> <p>Bolt catch damaged</p>	<p>Replace magazine and take damaged one to the maintenance shop</p> <p>Take USC to maintenance shop</p>
Magazine stuck in magazine well	<p>Magazine damaged</p> <p>Magazine catch defective</p>	<p>Replace magazine housing and take damaged one to the maintenance shop</p> <p>Take USC to maintenance shop</p>

Stoppage	Cause	Remedy
Cartridge not ignited	<p>Ammunition fault (Dud round)</p> <p>Firing pin damaged or broken</p> <p>Hammer spring damaged or broken</p>	<p>Replace round</p> <p>Take USC to maintenance shop</p> <p>Take USC to maintenance shop</p>
Bolt did not stay open on the last shot	Cartridge case stuck in chamber because it is deformed or the chamber is dirty	Unload. Retract bolt to eject spent case. Clean if fouled. If required take USC to maintenance shop
Cartridge case not extracted or ejected	<p>Chamber is dirty</p> <p>Extractor broken</p> <p>Ejector damaged</p> <p>Insufficient bolt recoil</p>	<p>Clean cartridge chamber</p> <p>Take USC to maintenance shop</p> <p>Take USC to maintenance shop</p> <p>Unload. Retract cocking lever to eject spent case. Check for smooth movement of bolt and check chamber for fouling. Clean if required.</p>

SIGHT ADJUSTMENT

If the point of impact has to be corrected, this will be done by adjustment of the rear sight using the Allen wrench provided with the weapon. The USC is zeroed at the factory to hit the point of aim at 25 meters (27.3 yards).

Elevation adjustment

- To lower the weapon's point of impact, turn the elevation adjustment screw clockwise.
- To raise the weapon's point of impact, turn the elevation adjustment screw counterclockwise.

NOTE: 1 revolution of the elevation adjustment screw changes the point of impact by 4.5 centimeters (1.77 inches) at a range of 25 meters (27.3 yards).

Windage adjustment

- To move the weapon's point of impact to the left, turn the windage adjustment screw counterclockwise.
- To move the weapon's point of impact to the right, turn the windage adjustment screw clockwise.

NOTE: 1 click of the windage adjustment screw changes the point of impact by 1.15 centimeters (.45 inches) at a range of 25 meters (27.3 yards).

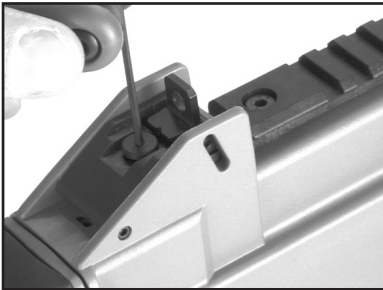
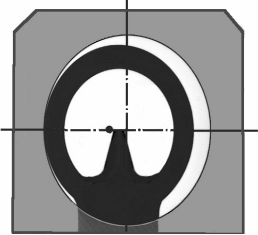
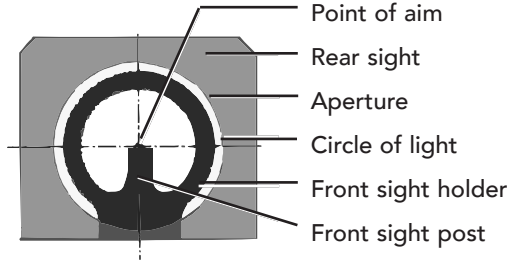

Fig. 40 Elevation adjustment

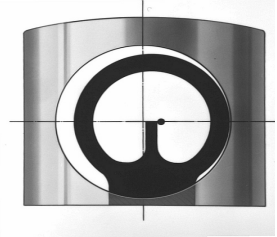

Fig. 41 Windage adjustment

Correct point of aim
Even circle of light



Impact as with incorrectly
centered front sight = left



Impact as with incorrectly
centered front sight = right

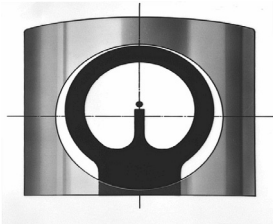

Impact as with full sight
= high

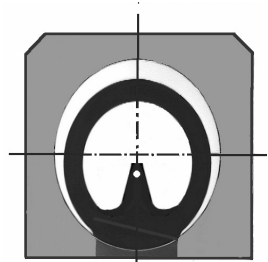

Impact as with fine sight
= low

Fig. 37 Sight pictures

EXPLODED DIAGRAM & PARTS LIST

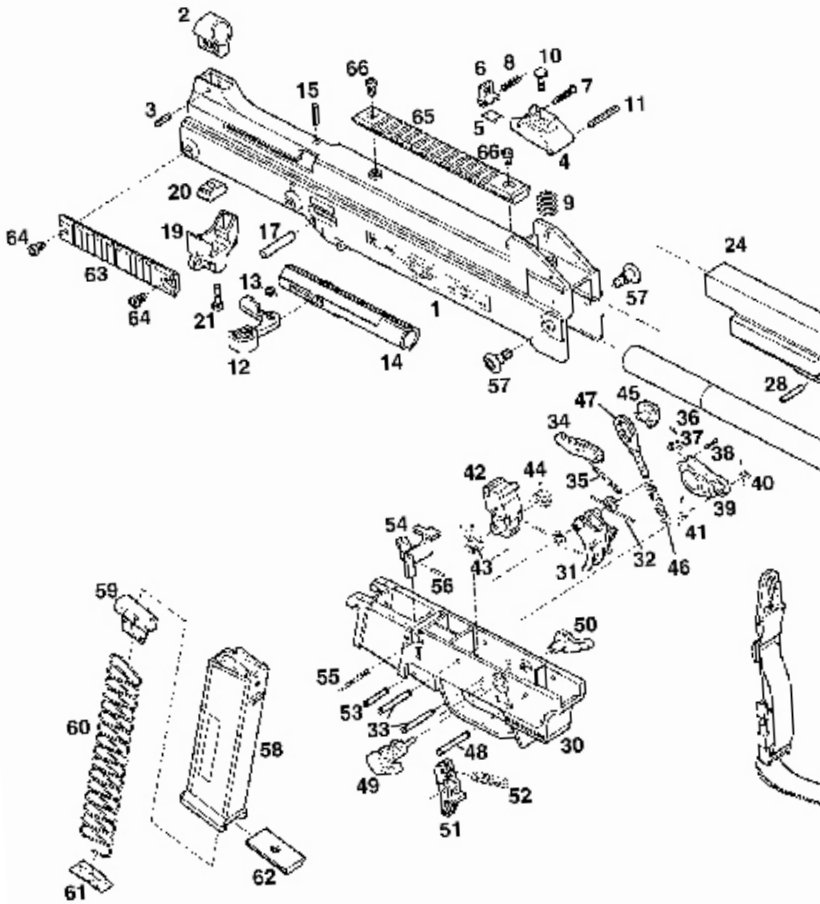

Item	Description	Part No.	Item	Description	Part
*	Upper receiver with barrel, complete (1 - 21)		*	Hand stop, complete. (19-21)	219364
1	Upper receiver, incomplete	219492	19	Hand stop, incomplete	219342
2	Front sight	217506	20	Insert plate, handstop	219343
3	Roll pin, front sight, 4 x 144 mm	928747	21	Cylindrical screw, handstop 5 x 16 mm	219414
*	Rear sight, complete (4 - 10)	217513	*	Buttstock, complete (24 - 25)	219496
4	Sight support	217504	22	Buttstock	217528
5	Flat spring	217515	23	Buffer	217544
6	Rear sight	217516	*	Bolt, complete .45 ACP (24 - 29)	219495
7	Windage adjustment screw	217517	24	Bolt, incomplete, .45 ACP	219499
8	Rear sight spring	217518	25	Extractor, .45 ACP	217573
9	Sight support spring	217503	26	Firing pin assembly, complete	217555
10	Elevation adjustment screw	217505	27	Firing pin spring	217523
11	Roll pin, sight support, 4 x 30 mm	987695	28	Firing pin retaining pin	217587
12	Cocking lever	217519	29	Recoil spring assembly, complete	217548
13	Cocking lever spring	217508	*	Lower receiver, complete (30-56)	219487
14	Cocking lever support	217507	30	Lower receiver, incomplete	219491
15	Roll pin, cocking lever support, 4 x 16 mm	986546	31	Trigger	205420
16	Barrel, .45 ACP	219497	32	Trigger spring	217918
17	Roll pin, barrel, 6 x 32 mm	988425	33	Axle (3x)	217532
18	Ejector	219399			

Fig. 38 USC
.45 ACP

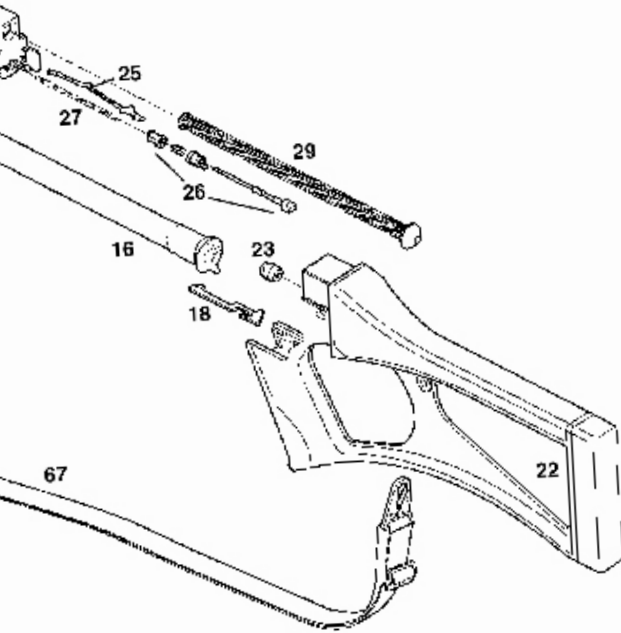

Item	Description	Part No.	Item	Description	Part
34	Sear, complete	205439	54	Bolt catch	217540
35	Sear spring	217917	55	Bolt catch spring	217539
*	Locking lever complete	219094	56	Roll pin,bolt catch, 2 x 12 mm	928080
36	Locking lever spring	214616	57	Allen screw, buttstock (2)	217903
37	Locking lever	219095	*	Magazine complete .45 (58 - 62)	219486
38	Bolt	214615	58	Magazine housing, .45 ACP	219522
39	Locking lever housing	214613	59	Follower .45 ACP	219523
40	Elbow spring right	217946	60	Magazine spring .45 ACP	219524
41	Elbow spring left	205201	61	Locking plate .45 ACP	219525
42	Hammer	217936	62	Floorplate	219526
43	Hammer spring, left	217533	*	Picatinny rail, short, complete with screws	219662
44	Hammer spring, right	217585	63	Picatinny rail, short	219660
45	Notched disk	217614	64	Cylindrical screw (2x)	219413
46	Compression spring	205418	*	Picatinny rail, long, complete (66 - 67)	219663
47	Index plate	205419	65	Picatinny rail, long	219661
48	Axle, locking lever	219521	66	Cylindrical screw (2x)	219413
49	Safety lever, left	217945	*	HK tool	988496
50	Safety lever, right	205437	67	Carrying sling, USC complete	214085
51	Magazine release	219530	*	Adaptor for UTL*	219693
52	Magazine release spring	217536			
53	Magazine release axle	219549	*	not pictured	

SPECIFICATIONS

Caliber45 ACP
Operating principle Simple blow back, firing from a closed bolt position

Dimensions

Overall length 900 mm (35.43 in)
Overall width 55 mm (2.17 in)
Overall height with magazine 243 mm (9.75 in)
Barrel length 406 mm (16 in)
Twist length 406 mm (16 in)
Sight radius 327 mm (12.87 in)

Weights

USC without magazine approximately 2.715 kg (6 lb.)
Magazine, empty (10 rounds) 0.098 kg (.216 lb.)
Carrying sling 0.10 kg (.22 lb.)

Other Data

Firing modes Semi-automatic
Sights Modular approach,
Standard adjustable mechanical sight,
Accessory mounting rails for optional aiming devices
Bore profile 6x polygonal, right-hand twist

WARRANTY REGISTRATION

New HK firearms are covered by Heckler & Koch, Inc.'s Limited Lifetime Warranty. Warranty registration is now online. To register your new HK firearm, go to: <https://hk-usa.com/warranty/registration/>

If you do not have access to the Internet, contact Heckler & Koch, Inc. to obtain a warranty registration form:

HK Customer Service
5675 Transport Boulevard
Columbus, GA 31907
Telephone: 706-701-5554.
Email: cs@heckler-koch-us.com

HECKLER & KOCH, INC. LIMITED LIFETIME WARRANTY

All new Heckler & Koch, Inc. firearms purchased after January 1, 1998, are warranted to the original retail purchaser only for the lifetime of the said original retail purchaser. In the event that this original retail purchaser, at the time of the original purchase, shall donate this firearm to another person, the donee name must be submitted during the online warranty registration. Heckler & Koch, Inc. does not guarantee or warrant that any, all, or some donations or gifts are valid and compliant with all applicable laws, regulations, and ordinances. Heckler & Koch, Inc. is not responsible or liable in any way for a donation or gift that does not comply with applicable laws, regulations, and ordinances. It is the responsibility of the original retail purchaser and the donee or recipient to ensure that any such transfer complies with all applicable laws, regulations, and ordinances. Upon completion of the online warranty registration indicating the name of the said donee, this warranty shall be extended to the lifetime of the said donee. This warranty applies only if the firearm was imported into the United States and distributed by Heckler & Koch, Inc. to an authorized dealer.

What Will We Do?

Heckler & Koch Inc. will, at its option, repair or replace without charge any HK firearm that fails due to a defect in materials or workmanship. Parts and labor are included. Repairs are warranted for the duration of the warranty. If Heckler & Koch, Inc. replaces a firearm under this warranty; you will receive a new warranty. Heckler & Koch, Inc. will return your firearm to you shipping pre-paid.

How to Obtain Service:

Contact Heckler & Koch, Inc. via phone at 706-701-5554 or email at cs@heckler-koch-us.com for a Return Authorization Number before sending your firearm freight prepaid to Heckler & Koch, Inc. at the address listed below. No C.O.D. shipments will be accepted.

Only the existing Heckler & Koch, Inc. Service Center or any other authorized Heckler & Koch, Inc. Service Center that may be established by Heckler & Koch, Inc. shall be authorized to make warranty repairs.

Return the complete, unloaded firearm with a detailed description of the problem using Heckler & Koch, Inc.'s Return Form.

DO NOT send any live ammunition with the firearm. If you must send ammunition to us for proof purposes, be sure that it is sent separately from the firearm.

We strongly recommend that you complete the online warranty registration at <https://hk-usa.com/warranty/registration/> to establish eligibility for warranty service. If you do not return an acknowledgment of online warranty registration to Heckler & Koch, Inc., you are required to provide adequate proof of the date that you purchased your new HK firearm at the time you send your firearm to Heckler & Koch, Inc. for warranty service.

In the event that this firearm was given as a gift at the time of original purchase, the online warranty registration with the name of the donee must be provided to Heckler & Koch Inc., in order for the warranty to become effective.

Note: Non-warranty servicing must follow the same shipping procedures as stated above. HK firearms with a valid Return Authorization Number should be shipped to the following address in accordance with these instructions:

HKI
Attn: Service Department/RA# _____
5675 Transport Blvd.
Columbus, GA 31907

Any information gathered in connection with a Heckler & Koch Inc. lifetime limited warranty shall be used for that purpose and may be used for other legitimate business purposes of Heckler & Koch Inc. For further information, please review Heckler & Koch, Inc.'s Privacy Policy, located at <https://hk-usa.com/cookie-policy-us/>

What Is Not Covered?

This warranty does not cover defects or damage caused by: (1) unreasonable use; (2) failure to provide proper care or maintenance; (3) failure to comply with instructions in the operator's manual including improper installation of original Heckler & Koch Inc. parts by the owner or his agent; (4) normal wear and tear for the degree of use; (5) rust or corrosion; (6) obstructions in the barrels; (7) excessive use; and/or (8) external and internal cosmetic finishes.

Heckler & Koch, Inc. reserves the right to determine what constitutes the unreasonable or excessive use of the firearm. All wooden parts and all accessories are excluded from warranty coverage.

This warranty does not cover any claims made by the second or subsequent owner of an HK firearm as stated above.

NOTICE Any unauthorized alteration or modification of the firearm or use of parts or components not originally made by Heckler & Koch, Inc. may void this warranty. Heckler & Koch, Inc. is not be responsible for any claims involving this firearm that result from the use of faulty, nonstandard, remanufactured, or reloaded ammunition or ammunition not manufactured to NATO, CIP, and/or SAMMI specifications.

Under no circumstances shall Heckler & Koch, Inc. be responsible or liable for incidental or consequential damages with respect to loss of use, loss of business or profits, other economic loss or injury to property, whether as a result of breach of express or implied warranty, negligence or otherwise. This Limited Lifetime Warranty applies only to retail purchases by individuals through an authorized Heckler & Koch, Inc. dealer.

Residents of CALIFORNIA, CONNECTICUT, DISTRICT OF COLUMBIA, HAWAII, MARYLAND, MASSACHUSETTS, MICHIGAN, NEW JERSEY, NEW YORK, AND U.S. TERRITORIES.

Any work involving replacement of the receiver of a firearm requires that the firearm be returned to a licensed firearms dealer. A current, signed copy of the dealer's FFL will be required. Please provide contact information for the chosen dealer, if applicable.

NOTICE Customers in restrictive capacity states: **DO NOT ship high capacity magazines to Heckler & Koch Inc. They cannot be returned.**

Exclusions

This lifetime warranty explicitly excludes firearms purchased by the United States military, government institutions or agencies of the United States or any of its constituent states and territories, law enforcement agencies of the United States or any of its constituent states and territories, and/or security organizations located within the United States or any of its constituent states and territories. Firearms purchased by these entities and organizations for duty issue to their personnel and/or employees are covered by a one-year limited warranty against material defects and workmanship or as agreed upon in a valid contract.

This lifetime warranty also excludes rimfire .22L R firearms, and all suppressors, which are covered by a one-year warranty.

Some states do not allow the exclusion or limitation of incidental or consequential damages, so the above limitations or exclusions may not apply to you. This warranty gives you specific legal rights, and you may also have other rights, which vary from state to state. This limited warranty is the only express warranty by Heckler & Koch Inc.

Heckler & Koch Inc. does not authorize any dealer or any other person to vary the terms of this warranty or make any other express warranties.

Heckler & Koch, Inc. Lifetime Barrel Guarantee

Heckler & Koch, Inc. guarantees the serviceability of the bore of the barrels of all MR A4 Series rifles and pistols for the lifetime of the original consumer purchaser for individual use. This guarantee is based on barrels meeting standards on accuracy, velocity, and useability across the entire life of the A4 system. If at any time an A4 barrel fails to meet these standards, Heckler & Koch, Inc. will replace the barrel.



Where to Get Further Help

If you have questions concerning this warranty, please contact Heckler & Koch, Inc.'s Customer Service Department at:
5675 Transport Blvd.
Columbus, GA 31907
Telephone: 706-701-5554
Email: cs@heckler-koch-us.com



HECKLER & KOCH
5675 Transport Boulevard
Columbus, Georgia 31907
Tel: (706) 568-1906
Customer Service: (706) 701-5554
Website: www.hk-usa.com