

SP5 SERIES OPERATOR'S MANUAL



HECKLER ★ KOCH

9 mm x 19

SAFETY RULES

Please read this operator's manual before handling your firearm. The following safety rules are placed in this manual by HK as an important reminder that firearm safety is your responsibility. Firearms can be dangerous and can potentially cause serious injury, damage to property or death, if handled improperly.

1. Never point a firearm at anyone or in any direction other than a SAFE direction, i.e. down range.
2. Treat all firearms as if they are always loaded.
3. Keep your finger off the trigger and outside of the trigger guard until your sights are aligned on the target and you are ready to fire.
4. Keep your finger off the trigger and outside of the trigger guard while loading or unloading the firearm.
5. Keep your finger off the trigger and outside of the trigger guard while pulling the firearm out of a holster/carry rig/case or while returning it to a holster/carry rig/case.
6. Be sure of your target and the backstop beyond.
7. Never give a firearm to or take a firearm from anyone unless the action is open and the magazine and/or chamber are free of any ammunition or brass.
8. Be sure that the ammunition you are using is factory loaded, is of the correct caliber for the firearm in which it is to be used, and that it is not damaged in any way.
9. Before firing, remove the magazine from the firearm, lock the action open, make sure the chamber is clear of any ammunition or brass, and check the barrel of the unloaded firearm for any possible obstructions.
10. Before firing any firearm that is unfamiliar to you, make sure that you understand exactly how it functions. A lack of familiarity with the firearm can result in serious accidents. Attend a certified training course on any firearm which you intend to use or with which you are not sufficiently familiar.
11. Always wear hearing and eye protection when using your firearm.
12. Keep all body parts, especially the hands and fingers, away from the muzzle to avoid injury or burns.
13. Be sure that no part of either hand touches or interferes with the bolt. The bolt is moved backward by the recoil force of the pistol during firing and may cause serious injury.
14. Firearms should be locked and stored separately from ammunition and beyond the reach of children and/or any untrained individuals.
15. Avoid the use of any alcoholic beverages or drugs before or during your use of a firearm.
16. Discharging firearms in poorly ventilated areas, cleaning firearms, or handling ammunition may result in exposure to lead; a substance known to be associated with birth defects, reproductive harm and other serious injury. Have adequate ventilation at all times. Wash hands thoroughly after exposure.

STOP! Know how to clear this pistol before attempting to operate.

1. Point the muzzle of the pistol in a safe direction and place the safety lever in the safe position. Ensure the muzzle is pointed in a safe direction and that the operator's fingers are off the trigger and outside the trigger guard. Place the safety lever in the SAFE position (white cartridge symbol with white "X" through it). Safety lever is located on both sides of the receiver.
 2. Remove the magazine. Depress the magazine release on the right side of the receiver (release lever for SP5) and remove the magazine from the magazine well.
 3. Open and lock the bolt to the rear. Grasping the charging handle on the left side of the receiver (located adjacent of the front sight) and move the bolt to the rear while keeping the muzzle pointed in a safe direction. Place the charging handle in the upward, locking recess notch. The bolt should be locked in the rear position. Watch for a cartridge or empty case to be ejected out through the ejection port.
 4. Inspect the chamber. Inspect the chamber for the presence of a cartridge or empty case by:
 1. Visually inspecting the chamber through the open ejection port.
 2. Physically inserting a finger through the magazine well and sweeping the chamber and feed ramp area.
 3. Removing any cartridges or empty cases from the chamber or from within the firearm.
- The SP5/SP5K pistol is now considered "Clear." Additional safety information appears throughout this manual.

WARNING! Read, understand, follow, and practice the safe firearms handling instructions put forth in this manual. Failure to follow the safety rules and safe firearm handling instructions taught in this manual may cause property damage, personal injury, and/or death.

SP5 SERIES Operator's Manual



HECKLER & KOCH

5675 Transport Boulevard
Columbus, Georgia 31907 USA
Tel: (706) 568-1906

USA Website: www.hk-usa.com • Email: cs@heckler-koch-us.com

© Heckler & Koch USA (Heckler & Koch Inc. and Heckler & Koch Defense Inc.) May 2026
All rights reserved, specifications and models subject to change without notice.

TABLE OF CONTENTS

Safety Precautions & Clearing	Inside Cover
Section 1 Introduction.....	5
Section 2 Nomenclature	6
Section 3 Specifications	10
Section 4 Function & Operation	11
Operating Principle in Brief	12
Cycle of Operation	12
Safety/Selector Lever Function	13
Section 5 Sights, Aiming, and Sight Adjustment	14
Sights.....	14
Aiming.....	14
Sight Adjustment.....	15
Section 6 Ammunition	18
Section 7 Instructions for Use	19
Clearing Procedure	19
Filling & Emptying the Magazine	20
Loading	20
Firing.....	21
Unloading	22
Selection and Use of a Holster or Carry Sling.....	23
Storage & Transport	23
Section 8 Disassembly.....	23
Disassembly into Assembly Groups	24
Section 9 Assembly	26
Assembly Groups.....	27
Function Check	28
Section 10 Cleaning & Maintenance	29
Cleaning	29
Inspection	30
Lubrication	31
Troubleshooting Problems & Repair	33
Section 11 Warranty Registration Information.....	34
Section 12 SP5K Accessories.....	36
Section 13 SP5 Series Exploded View & Parts List	40
Firearms Service Record	44

SECTION 1 INTRODUCTION

The SP5 Series was developed by Heckler & Koch as a semi-automatic, civilian sporting pistol (hence the "SP" prefix) that matches the look and ergonomics of the famous MP5 submachine gun. It is actually the second iteration of an HK commercial/civilian model inspired by the MP5 design.

The SP5 Series is designed and manufactured to meet the strict definition of a civilian pistol in the USA and cannot be altered to fire in the fully automatic mode.

For more comfortable shooting, the SP5 Series is equipped with an elastic "bungee" sling. The sling is easily installed by snapping it onto the sling swivel hardware located on the rear of the receiver. Using the sling makes firing the SP5 Series more stable and less fatiguing.

When shooting, the operator should push the SP5 Series forward against the tension of the sling using a two-handed grip; ensuring the forward hand gasps the handguard and that hands and fingers are kept well away from the front of the muzzle.

ALL NFA RULES APPLY.

WARNING: 1. The addition of the HK stock to a HK type pistol with a barrel shorter than 16 inches in length results in the manufacturing of a short-barreled rifle (SBR) which falls within the classification of firearms subject to NFA controls [26 U.S. Code §5845(a)(3)]. Even if the pistol is not assembled into the butt stock, possession of the pistol and the butt stock would constitute a short barrel rifle (SBR) which may not be lawfully possessed unless it is registered to the possessor in the National Firearms Registration and Transfer Record in advance.

2. The Addition of the HK stock to a HK type pistol with a barrel of 16 inches in length or longer results in the manufacturing of a lawful sporting rifle. Prior to converting the pistol into a rifle, ensure you follow the guidance in 18 U.S. Code § 922 (r) and 27 CFR 478.39. It is YOUR responsibility to ensure that all laws and regulations are followed.

SECTION 2 NOMENCLATURE



Fig. 1 – SP5 Assembly

- | | |
|--------------------------------|------------------------------|
| 1 Locking pin | 8 Trigger |
| 2 Cap | 9 Pistol grip |
| 3 R Safety lever, ambidextrous | 10 Sling |
| 4 Magazine well | 11 Eyelet for carrying sling |
| 5 Magazine | 12 Charging handle |
| 6 Paddle release | 13 Front sight |
| 7 Trigger guard | |

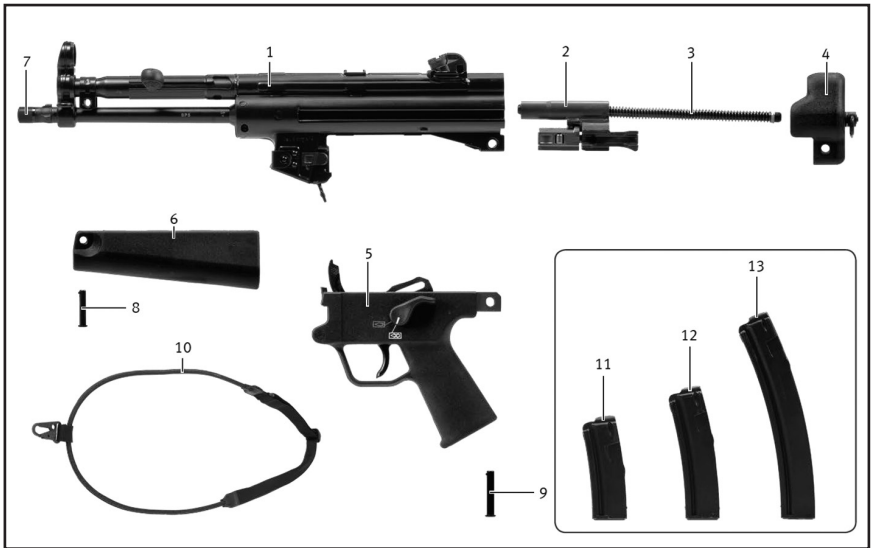

Fig. 2 – SP5 Assembly

- | | |
|---------------------------|-----------------------------------|
| 1 Receiver | 8 Locking bolt for handguard |
| 2 Bolt | 9 Lockng bolt for pistol grip/cap |
| 3 Recoil spring guide rod | 10 Carry sling |
| 4 Cap | 11 10 round magazine |
| 5 Pistol grip | 12 15 round magazine |
| 6 Handguard | 13 30 round magazine |
| 7 Protective Cap | |

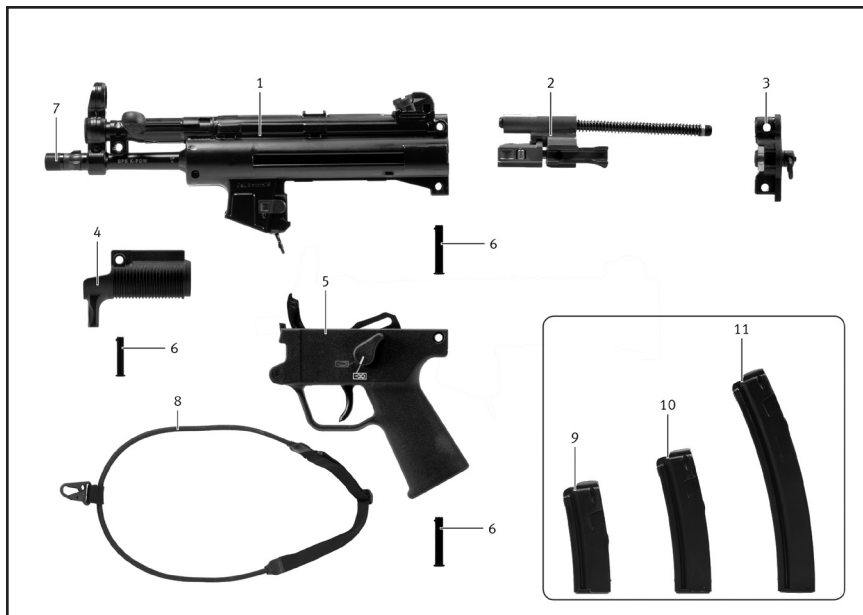

Fig. 4 – SP5K-PDW (left side view)

- | | |
|-----------------------|----------------------|
| 1 Receiver | 8 Elastic sling |
| 2 Bolt group, compl. | 9 10 round magazine |
| 3 Cap, compl. | 10 15 round magazine |
| 4 Handguard | 11 30 round magazine |
| 5 Pistol grip, compl. | |
| 6 Locking pin (3x) | |
| 7 Safety cap | |

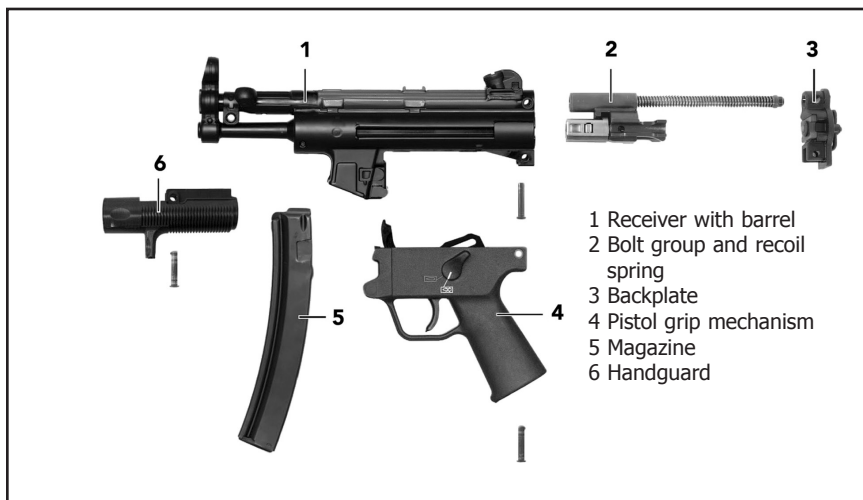

Fig. 5 – SP5K Assembly Groups

SECTION 3 SPECIFICATIONS

SP5 SPECIFICATIONS

Caliber	9 mm x 19
Operating Principle	Recoil operated
Locking System	Roller-delayed blowback
Magazine Capacity	10, 15, 30 rounds

DIMENSIONS & WEIGHT

Length	17.8 inches / 452 mm
Width	2.48 inches / 63 mm
Height	8.66 inches / 220 mm
Barrel Length	8.86 inches / 225 mm
Sight Radius	10.2 inches / 260 mm

Weight (without magazine)	5.1 lb (2500 grams)
Weight (empty magazines)	30rd-6.3 oz/180 g, 10rd-3.5 oz/110 g

OTHER DATA

Trigger Pull	6.74-10.11 pounds-force / 30-45 N
Return Travel	.12 inches / 3 mm
Trigger Travel	.24 inches / 6 mm
Barrel Profile/Twist	Groove/land profile, 6 grooves, right-hand twist, 1/2"x28"

SP5K SPECIFICATIONS

Caliber	9 mm x 19
Operating Principle	Roller-delayed blowback
Mode of Fire	Single fire
Magazine Capacity	30, 15, 10 rounds
Cartridge case ejection	Right side

DIMENSIONS & WEIGHT

Length	13.9 inches (354 mm)
Width	2.40 inches (61 mm)
Height	8.66 inches (220 mm)
Barrel Length	4.53 inches (115 mm)
Sight Radius	10.2 inches (260 mm)
Weight (without magazine)	4.64 pounds (2.11 kilograms)
Magazine Weight (empty 30, 15, 10-rd)	6 oz (170 g), 4.23 oz (120 g), 3.88 oz (110 g)

OTHER DATA

Trigger Pull	Approx. 6.74-10.11 pounds-force (30-45 Newtons)
Trigger Travel	.24 inches (6 mm)
Return Travel	.12 inches (3 mm)
Barrel Profile/Twist	Groove/land profile, 6 grooves, right-hand twist

MISCELLANEOUS

Warranty	Limited Lifetime Warranty for the original retail (commercial/civilian) purchaser, one year for law enforcement and military customers
Safety	Selector/safety lever, firing pin spring
Disassembly	No tools required for user field strip

SECTION 4 FUNCTION AND OPERATION

OPERATING PRINCIPLE IN BRIEF

The cycle of operation is a reoccurring sequence of mechanical events which takes place in the operation of this self-loading firearm.

There are three commonly accepted operating principles used to operate an auto loading firearm. They are utilization of the kinetic energy released as the round is fired. The powder in a modern cartridge is converted in a half dozen milliseconds from a dry powder to expanding gases 900 to 1,000 times the volume of the powder. Additionally the pressure of this expanding gas can average 38,000 psi with a peak of over 43,000 psi in a 9 mm x 19 cartridge.

This firing causes many things to happen. First, as the gases expand the bullet moves from the case into the barrel and the force required to move the bullet causes an exact force to be exerted in the opposite direction. This will become recoil energy and is the power behind two of the operating principles.

Second, the gases behind the bullet are continuing to expand. They push the bullet down the bore imparting spin to the bullet by the inscription of the bullet on the lands and grooves of the bore. These grooves are in the shape of a spiral which makes the bullet turn as it travels down the barrel. It can achieve a rate of spin of almost 80,000 rpm in a 9 mm. The expanding gases if vented and applied to pistons or rods can be made to power the mechanism of the auto loader.

One of the features of the gas operated gun is that the barrel is stationary and that the gas is vented from the barrel forward of the mid point of the barrel. This creates a delay which enables the bullet to leave the muzzle and the pressure to drop to a safe level prior to the action opening.

In the recoil operated system the barrel and breech, barrel and bolt, barrel and slide remain closed while the mechanism is in recoil until the bullet leaves the bore and the pressure drops to a safe level. This is done through timing, but the barrel in a recoil system moves. Examples are numerous as all Browning design pistols are recoil operated including pistols like the HK USP series, HK45 series, P30 series, P2000 series, and VP series.

Blowback is another method of operation using recoil energy and includes two types, simple and the delayed. The simple blowback system uses the mass of the bolt to cause the delay necessary for the bullet to leave the muzzle. Many fully automatic submachine guns and .22 LR semi-automatic firearms use simple blowback.

Delayed blowback however, instead of using the mass of the bolt, incorporates a mechanical "disadvantage" which must be overcome to unlock the bolt and open the action. In the case of the HK SP5 Series (and the HK MP5) disadvantage is caused by the rollers engaging the barrel extension and locking piece. This type of bolt system enables the bolt mechanism to be lightweight.

The SP5 Series and MP5 function through the utilization of the symmetrical transmission of energy. The equal and opposite reaction to the bullet traveling down the bore provides more than enough energy to function the gun.

CYCLE OF OPERATION

The cycle of operation is a reoccurring sequence of mechanical events which takes place in the operation of a self-loading firearm. The sequence for the SP5 Series pistols begins with a loaded magazine inserted into the magazine well.

1. FEEDING Removing a round from the magazine.

As the bolt moves forward under the pressure of the expanding recoil spring, the feeding pawl on the bolt head rides between the lips of the magazine stripping a round out of the magazine and feeding it into the chamber.

2. CHAMBERING Placing the round in the chamber of the barrel and seating it fully.

The bolt pushes the round forward into the chamber until the mouth of the cartridge comes to rest on the end of the chamber.

3. LOCKING - Closing and locking of the breech mechanism prior to firing.

The bolt, being pushed by the recoil spring, continues to apply pressure to the base of the cartridge until the extractor cams out allowing the bolt to snap forward. The front of the bolt head hits the back of the barrel and stops its forward movement. Once the bolt head has stopped moving, the bolt carrier and locking piece continue forward for about 4mm until the locking piece forces the locking rollers out into the locking recesses of the barrel extension.

4. FIRING - Ignition of the propellant powder.

The trigger is pulled and pushes up on the rear of the sear causing the front to move down releasing the hammer. The hammer falls to the firing pin and overcomes the tension of the firing pin spring driving the firing pin into the primer. The primer detonates, igniting the propellant powder and firing has occurred. When the sear releases the hammer the spring in the sear causes the sear to travel a predetermined motion. This setting of the sear allows SEMI-AUTOMATIC fire and the sear is reset to catch the hammer before the hammer hits the firing pin.

5. UNLOCKING Removal of any blocking mechanism from the breech so the breech can open.

The resultant force of the cartridge firing creates an impact on the bolt head that sends force through the rollers into the locking piece, knocking it to the rear. Once the locking piece moves from between the rollers, the bolt is unlocked.

6. EXTRACTING removal of the fired cartridge case, or a round from the chamber.

As the bullet is leaving the cartridge case, expanding gases pressurize the inside of the case and the flutes in the chamber. This prevents the case from sticking to the wall of the chamber and residual gas pressure floats the case out of the chamber on this film of high pressure gas.

7. EJECTING - Expulsion of the round or fired case from the gun.

The extractor holds the empty case to the face of the bolt head as it travels to the rear. The carrier rides over the rear of the ejector and the front comes up through the face of the bolt hitting the case as the bolt moves to the rear. The extractor creates a pivot and the ejector provides thrust as the case is knocked out of the ejection port.

8. COCKING - Resetting of the trigger mechanism to enable subsequent shots to be fired. NOTE: cocking is NOT complete at this time!

While the bolt moves to the rear the hammer is pushed back and the bolt rides over it. When the bolt moves forward for the next cycle the hammer starts forward. The shooter

releases the trigger causing the sear to snap back into position and the firearm is ready for the next shot.

SAFETY/SELECTOR LEVER FUNCTION

NOTE: The SP5 Series has ambidextrous selector/safety levers, that is safety levers located on both sides of the lower receiver. Either lever can be manipulated and moves the lever on the other side. Unlike some firearms, the selector/safety levers can be placed on the "SAFE" position even if the firearm is not cocked.

"SAFE POSITION" – Place the selector lever with the point facing towards the closed white box containing a bullet symbol with an "X" over it (downward, Fig. 6).

"FIRE POSITION" – Place the selector lever with the point towards the closed red box containing a red bullet symbol in it (upward, Fig. 7).

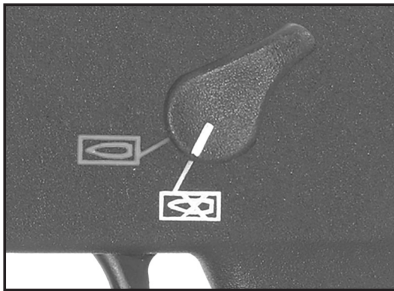

6 – Selector lever on SAFE

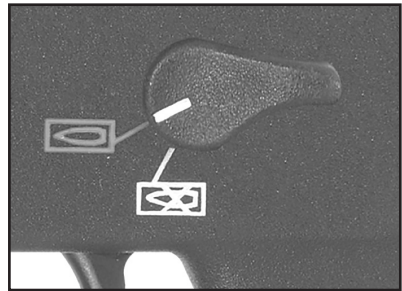

Fig. 7 – Selector lever on FIRE

Fig.

SECTION 5 SIGHTS, AIMING, AND SIGHT ADJUSTMENT

SIGHTS

The SP5 Series is equipped with the same sighting system installed on the HK MP5K and the SP89 — a protected front sight blade (Fig. 9) and an adjustable rear drum (Fig. 8) with various width notches for precise shooting and rapid target acquisition.



Fig. 8 – Rear Sight

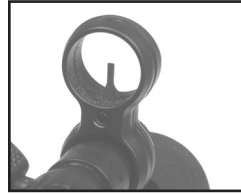

Fig. 9 – Front Sight

NOTE: HK SP5 Series pistols are test fired for accuracy by ensuring the point of aim equals point of impact at 25 meters (27.3 yards). Individual results concerning accuracy and/or shot placement are affected by such factors as stance, grip, engagement range, and ammunition. Use of different types of ammunition can change the elevation and windage of the position of point of impact. The sights can be adjusted to correct changed position of point of impact.

AIMING

The correct sight alignment and “sight picture” is depicted in Fig. 10 below. Common sight alignment errors are shown in Fig. 11.

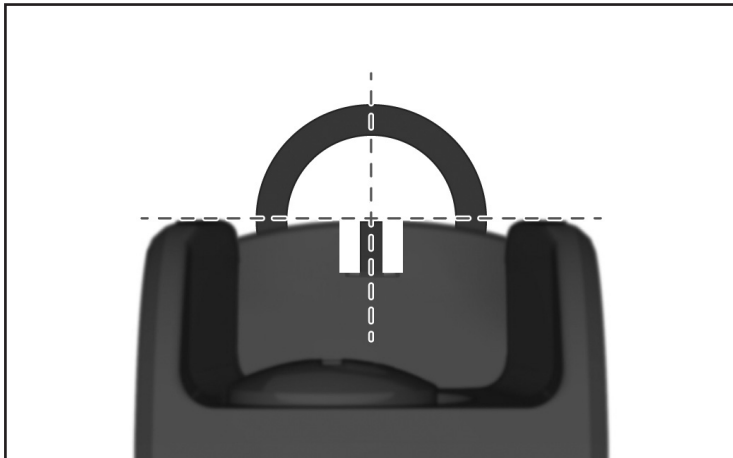

Fig. 10 – Correct sight alignment

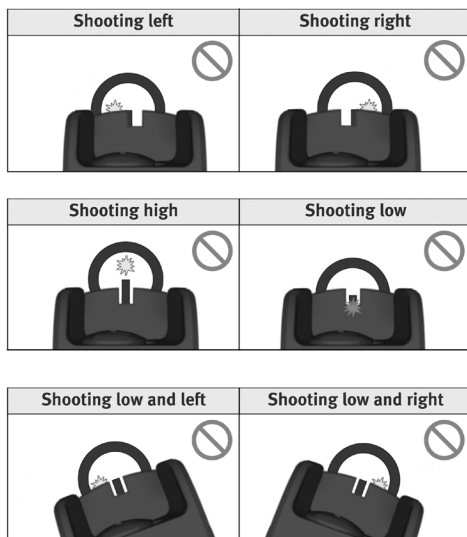

Fig. 11 – Common sight alignment errors

SIGHT ADJUSTMENT

Sight adjustment for the SP5 Series is made on the rear sight drum. The rear sight can be adjusted for precise shooting or for rapid target acquisition. Movement of the sight will be in the same direction the shooter wants the impact of the round to move. If the hit is to the right of the intended target, then the sight and the impact must be moved left. For precise shooting, adjust the rear sight to a narrow notch (Fig. 12). For rapid target acquisition, adjust the rear sight to a wide notch (Fig. 13).



Fig. 12 – Narrow sight notch

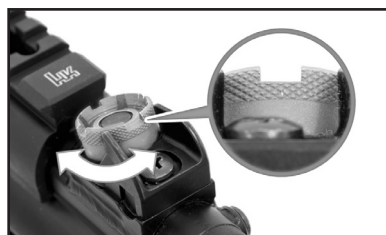

Fig. 13 – Wide sight notch

Use an HK sight adjustment tool (Fig. 14, HK part # 3000009) to adjust the rear sight. The sight adjustment tool includes two components, a Phillips screwdriver and an elevation adjustment module (stored in the handle of the screwdriver).

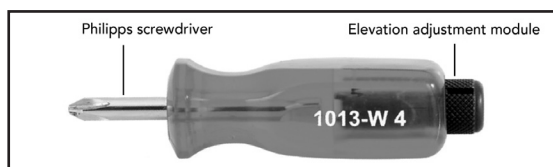

Fig. 14 – HK sight adjustment tool

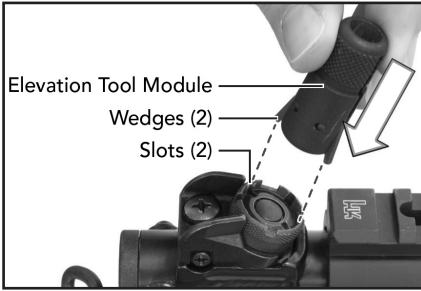

Fig. 15 – Insert elevation tool module into rear sight

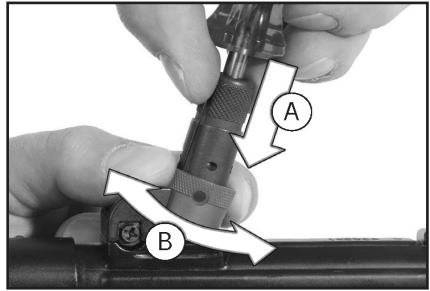

Fig. 16 – Adjust rear sight

Elevation Adjustment – Point of Impact TOO HIGH



1. Insert the elevation tool module into rear sight while inserting the wedges of the tool into the slots of the rear sight (Fig. 15).
2. Insert the Phillips-head screwdriver into the elevation adjustment tool module (A), press downwards and hold it (Fig. 16).
3. Turn rear sight drum counter-clockwise (B) (Fig. 16). Turning by one click changes the point of impact by approximately 1.375 cm (0.55 inches) at 25 meters (27.34 yards or 82 feet) range.
4. After correction withdraw the Phillips-head screwdriver and remove elevation tool module. The catch bolts will then re-engage in the slots. After performing the elevation adjustment set the desired sight notch again.

Elevation Adjustment – Point of Impact TOO LOW



1. Insert the elevation adjustment module tool into rear sight while inserting the wedges of the tool into the slots of the rear sight (Fig. 15).
2. Insert the Phillips-head screwdriver into the elevation adjustment tool module (A), press downwards and hold it (Fig. 16).
3. Turn rear sight drum (B) clockwise (Fig. 16). Turning by one click changes the point of impact by approximately 7 cm (2.76 inches) at 25 meters (27.34 yards or 82 feet) range.
4. After correction withdraw the Phillips-head screwdriver and remove elevation tool module. The catch bolts will then re-engage in the slots. After performing the elevation adjustment set the desired sight notch again.

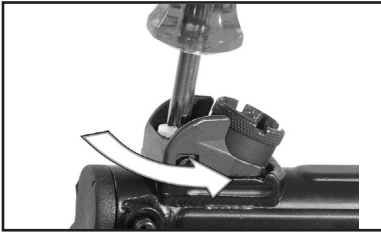

Fig. 17 – Loosen screw

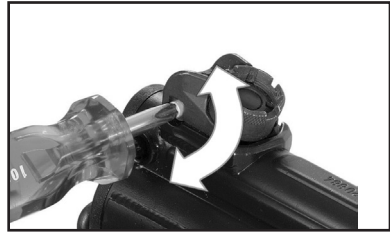

Fig. 18 – Turn windage
Adjustment screw

Windage Adjustment – Point of Impact TOO FAR RIGHT



1. Loosen screw by turning counter-clockwise with Phillips-head screwdriver (Fig. 17).
2. Turn windage adjustment screw clockwise (Fig. 18).
3. Tighten screw by turning clockwise with Phillips-head screwdriver.

Windage Adjustment – Point of Impact TOO FAR LEFT



1. Loosen screw by turning counter-clockwise with Phillips-head screwdriver (Fig. 17).
2. Turn windage adjustment screw counter-clockwise (Fig. 18).
3. Tighten screw by turning clockwise with screwdriver.

Any corrections which may be required when sighting-in the SP5 Series should be performed by adjusting the rear sight for elevation or windage. The pistols are designed to be sighted in at a range of 25 meters. REMEMBER THIS HELPFUL FORMULA: LL=C (Lower or Left = Clockwise rotation)

SECTION 6 AMMUNITION

WARNING! HK specifically disclaims any responsibilities for any damage or injury that should occur because of, or as a result of, the use of faulty, remanufactured, or reloaded (hand loaded) ammunition, or of cartridges other than those for which the pistol was originally chambered for.

HK SP5 Series pistols are designed to fire quality, factory-loaded ammunition, loaded to NATO or SAAMI (Sporting Arms and Ammunition Manufacturers' Institute) specifications for use specifically in handguns.

The following guidelines should be considered when selecting the correct ammunition for your pistol:

1. Be sure the ammunition you have chosen is compatible with your pistol-proper caliber, cartridge, bullet weight, etc.
2. Prior to loading the magazine and chamber, carefully inspect all cartridges for the following abnormalities:
 - Cracked, split, dirty or corroded cases
 - Improperly seated projectiles and/or primers
 - Damaged projectiles.
3. Do not attempt to fire a cartridge in which the projectile has been forced back into the case. Upon firing, this condition may result in increased chamber pressure above safe limits.
4. DO NOT USE:
 - Reloads or remanufactured ammunition.
 - Aluminium or steel cased ammunition.
 - Non-jacketed or exposed lead ammunition.
 - Corrosive ammunition (primer and/or propellant).
 - Foreign and/or outdated military surplus
 - Any ammunition that exceeds NATO or SAAMI (Sporting Arms and Ammunition Manufacturers' Institute) pressure limits.
 - Corroded ammunition.
 - Dented Cartridges.
 - Cartridges with loose bullets.
 - Cartridges exposed to extreme heat above 135°F (57°C) until they have cooled.
 - Use only authorized ammunition that is manufactured to NATO and SAAMI specs.
 - Ammunition that is wet or dirty.
 - Ammunition exposed to oil, grease, water or direct sunlight. If possible, remove contaminants before use and cool down ammunition exposed to direct sunlight or heat. (Exposure to sources of heat could raise the chamber pressure of the cartridge above safe limits.)

WARNING! HK firearms are designed to function with quality, manufactured brass-cased ammunition. Use of steel or aluminum-cased cartridges is not recommended and could adversely affect safe and reliable functioning. Use of cast-lead bullets is also not recommended.

NOTE: HK handguns are safe for use with new, high-quality U.S. factory ammunition manufactured to SAAMI specifications. For further information go to www.saami.org or contact the manufacture of your ammunition directly.

SECTION 7 INSTRUCTIONS FOR USE

Know how to clear an SP5 Series pistol before attempting to operate.

CLEARING PROCEDURE

1. Point the muzzle of the pistol in a safe direction and place the safety lever in the safe position. Ensure the muzzle of the firearm is pointed in a safe direction and that the operator's fingers are off the trigger and outside the trigger guard. Place the safety lever in the SAFE position (white cartridges symbol with white "X" through it). Safety lever is located on both sides of the receiver.

2. Remove the magazine. Depress the magazine release button on the right side of the receiver (Fig. 19[Ⓐ]) or paddle on the SP5. Remove the magazine from the magazine well (Fig. 19[Ⓑ]).

3. Open and lock the bolt to the rear. Grasping the charging handle on the left side of the receiver (located adjacent of the front sight) and move the bolt to the rear while keeping the muzzle pointed in a safe direction (Fig. 20). Place the charging handle in the upward, locking recess notch (Fig. 21 [Ⓐ] and [Ⓑ]). The bolt should be locked in the rear position. Watch for a cartridge or empty case to be ejected out through the ejection port.

4. Inspect the chamber. Inspect the chamber for the presence of a cartridge or empty case by (Fig. 22):

1. Visually inspecting the chamber through the open ejection port.
2. Physically inserting a finger through the magazine well and sweeping the chamber and feed ramp area.
3. Removing any cartridges or empty cases from the chamber or from within the firearm.

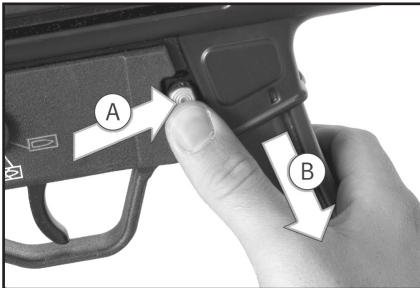

Fig. 19 – Remove the magazine



Fig. 20 – Move the bolt rearward

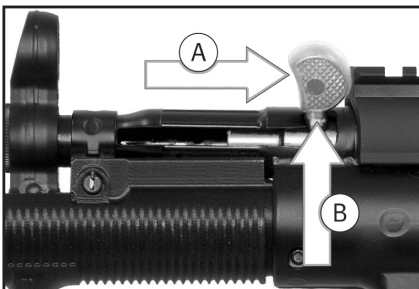

Fig. 21 – Lock the bolt rearward



Fig. 22 – Check the chamber



Fig. 23 – Depress the SP5 magazine release lever or button.



Fig. 24 – Remove the magazine from the magazine well.

FILLING AND EMPTYING THE MAGAZINE

NOTE: Do not attempt to load more than the prescribed number of cartridges into the magazine. Do not alter the shape of the magazine housing, follower or spring. To do so may cause stoppages or the magazine may not seat properly in the pistol.

Filling the Magazine

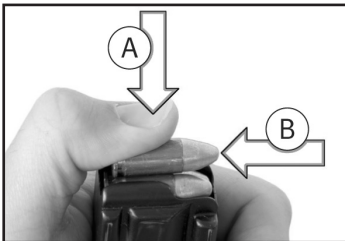

Fig. 25 – Loading the magazine

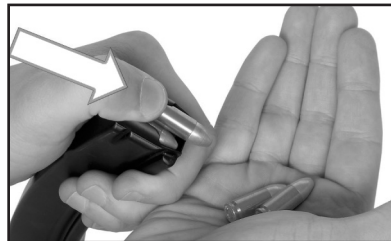

Fig. 26 – Unloading the magazine

1. Hold the magazine in the non-firing hand with the back side of the magazine resting against the palm .
2. Using the firing hand, hold a cartridge between the index finger and thumb with the projectile facing the palm.
3. Press the rim of the cartridge down against the forward edge of the magazine follower or on the top cartridge already in the magazine (Fig. 25 Ⓐ).
4. Slide the cartridge back into the magazine under the feed lips (Fig. 25 Ⓑ).
5. Repeat steps 1-4 until the magazine is full. Do not overfill the magazine.

Emptying the Magazine

Exert pressure with a finger on the base of the cartridge (Fig. 26) and push each cartridge forward out of the magazine until the magazine is empty.

LOADING

1. Lock charging handle rearward. Ensure the safety lever is in the "SAFE" position.
2. Pull charging handle all the way back and hold it (Fig. 27 Ⓐ).
3. Lock charging handle upwards in place into recess notch in receiver (Fig. 27 Ⓑ). The bolt group is held in rear position.

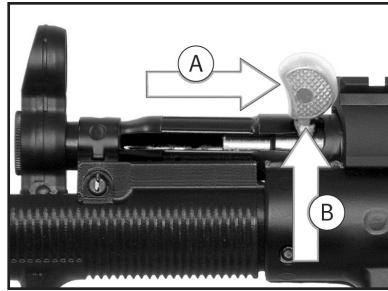

Fig. 27 – Lock charging handle

4. Insert magazine. When inserting the magazine into the SP5 Series pistols, the bolt group should be locked in the rearward position.
5. Insert full magazine into the firearm until the magazine catch engages.

WARNING! Risk of injury or death from accidental discharge of SP5 Series! A loaded SP5 Series pistol is always a potential source of danger. Only load the firearm immediately before firing and unload the firearm immediately after firing.

6. Pull the charging handle all the way back.
7. Let the charging handle snap forwards. The firearm now has a round in the chamber and is set to "SAFE". If the charging handle is locked back in the recess notch, vigorously slap it downward with your non-firing hand. Do not "ride" the bolt forward.

WARNING! Dropping and/or jarring a loaded firearm may result in a discharge of the firearm, even if the safety is in the "SAFE POSITION." It is the operator's responsibility to always keep the muzzle pointed in a safe direction, maintain control of the firearm, and keep the firearm unloaded until it is ready to be discharged. An uncontrolled discharge may cause property damage, personal injury and/or death.

FIRING

The HK SP5 Series is equipped with a bungee-type carrying sling (Fig 28 & 29). Using the carrying sling for additional support while shooting provides the most stable firing position and offers the prospect of the best possible hit results. When shooting, press the firearm forward against the force of the carrying sling (Fig. 29). Using the carrying sling also prevents the firearm from falling and striking the ground.

WARNING!

- 1. Be sure of your target and what's behind it! A bullet from a pistol travels as far as a mile. It can easily penetrate wood or plasterboard walls or even a car door.**
 - 2. Be sure that your hands and all parts of your body are kept away from the muzzle of your pistol at all times!**
 - 3. Always wear eye and ear protection when firing the pistol.**
-



Fig. 28 – Sling snap-hook attached to SP5K backplate eyelet position

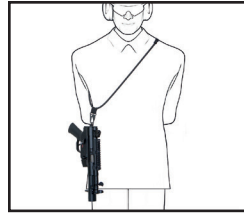

Fig. 29 – SP5K sling carry

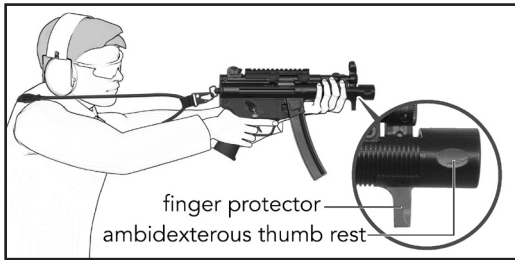

Fig. 30 – Two-handed grip firing position (with carry sling)

1. Acquire the proper sight alignment and sight picture (see Fig. 10, page 14).
2. Click safety lever to the "FIRE" position.
3. Gradually squeeze the trigger straight to the rear while attempting to avoid disruption to the sight picture and alignment.
4. Practice good follow-through techniques by maintaining proper sight picture and trigger squeeze until after the firearm has discharged.
5. After firing, or to reload, click the safety lever to the "SAFE" position.

WARNING! Risk of injury from reaching in front of the muzzle while firing. Shooters should avoid reaching in front of the muzzle while firing. Hold by the handguard and place the thumb on the thumb rest of the handguard.

UNLOADING

1. With the muzzle pointed in a safe direction, place the firearm on safe by moving the selector lever to "SAFE" position (white cartridge symbol with X through it).
2. Remove magazine by grasping magazine housing, press magazine catch (A) and remove magazine (B) (Fig. 31).

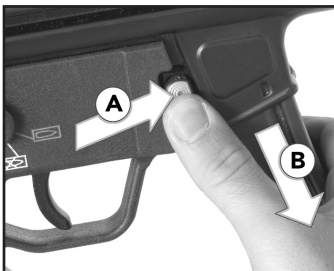

Fig. 31 – Unloading

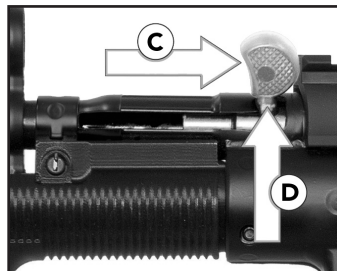

Fig. 32 – Unloading

3. Pull the charging handle © all the way back and place it in the recess notch ©. A cartridge will be ejected if rounds were present in the magazine. If the magazine was empty, no cartridge will be ejected.



Fig. 33 – Depress the SP5 magazine release lever or button.



Fig. 34 – Remove the magazine from the magazine well.

NOTE: Risk of material damage from dropping the magazine! Dropping a magazine can damage the magazine lips and cause malfunctions. Remove the magazine by hand and avoid impacts on the magazine lips.

SELECTION AND USE OF A HOLSTER OR CARRYING SLING

Normally the SP5 Series will be used with an HK carry sling and not a conventional holster due to its size. Slings, holsters, and carry rigs designed for use with the MP5K will usually function with the SP5 Series. For more information, please contact HK Customer Service.

STORAGE AND TRANSPORT

1. Store or transport the pistol and its components clean and lubricated.
2. Store and transport the pistol without cartridges in the chamber, magazine or in the storage container.
3. Store and transport the pistol with the bolt forward and the hammer down (uncocked).
4. Clean and lubricate the pistol and its components at least every twelve (12) months during storage.
5. Store the pistol and its components in a clean, dry, dust-free environment with regulated temperature controls.
6. Store the pistol and ammunition separately under lock and key.

SECTION 8 DISASSEMBLY

DISASSEMBLY INTO ASSEMBLY GROUPS

WARNING! Risk of injury from improperly assembled SP5 Series! Improper assembly can compromise the safety and functioning of the SP5 Series. Only disassemble the SP5 Series pistols to the extent described in this manual.

1. Clear the firearm and carry out a safety check.
2. Push in locking pins for back plate and pull it out (Fig. 35). Note: SP5 has only one pin.
3. Remove back plate to the rear.
4. Remove pistol grip downwards (Fig. 36).
5. Pull bolt group and recoil spring rearwards out of the receiver (Fig. 37).
6. Push in locking pin for handguard and pull it out.

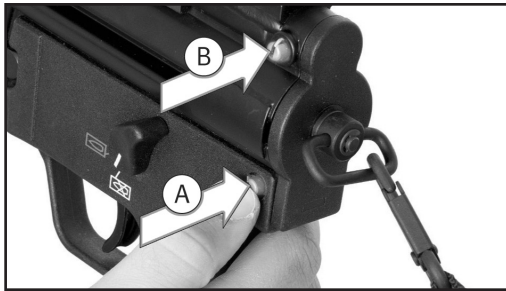

Fig. 35 – Push in locking pin for back plate



Fig. 36 – Remove pistol grip

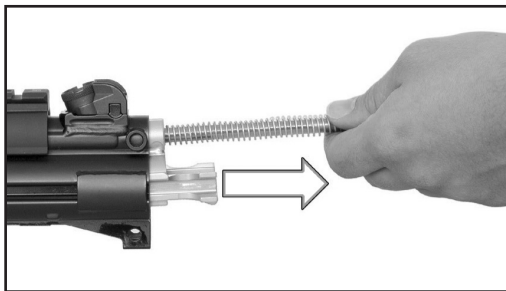

Fig. 37 – Remove bolt group and recoil spring

7. Pull handguard towards muzzle (A) and downwards (B) to remove it (Fig. 38).

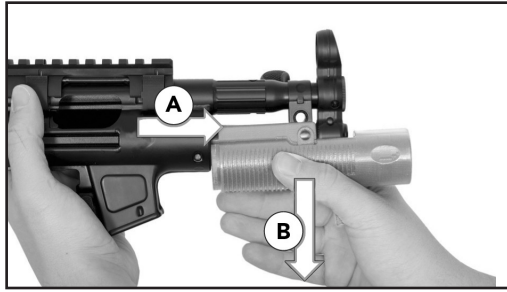

Fig. 38 – Remove pistol grip

Disassemble bolt group

1. Disassemble the firearm into assembly groups.
2. Turn locking piece clockwise (Fig 39 (A))
3. Remove locking piece from bolt head carrier by bringing in forward (Fig. 39 (B))
4. Remove firing pin and pressure spring for firing pin forwards out of the bolt head carrier (Fig. 40).

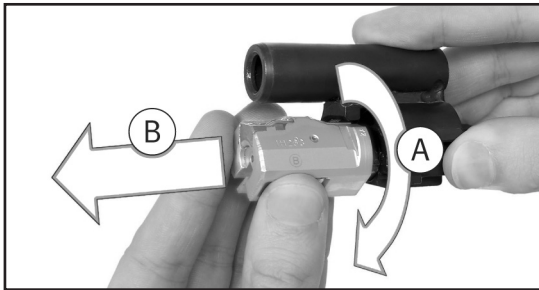

Fig. 39 – Remove the bolt head

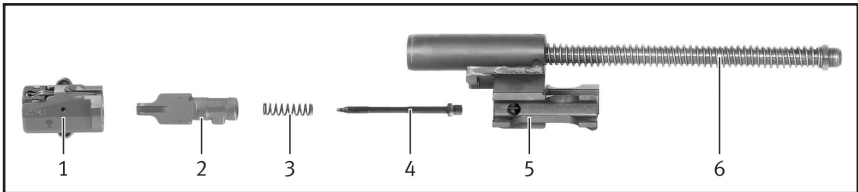

Fig. 40 – Components of the bolt group

- | | |
|----------------------------------|-----------------|
| 1 Bolt head | 4 Firing pin |
| 2 Locking piece | 5 Bolt group |
| 3 Pressure spring for firing pin | 6 Recoil spring |

Removal of Picatinny Rail Scope Mount (SP5K Only)

Only remove the Picatinny rail scope mount if it is damaged. Removal and installation of the rail scope mount requires a Torx TX15 insert. For installation, use of a torque wrench is recommended. Torque setting of 3 Nm/.67 pounds-force (lbf).

1. Place Torx insert in torque wrench.
2. Adjust torque wrench.
3. Loosen screws for Picatinny rail scope mount by turning counter-clockwise with the torque wrench (Fig. 41).
4. Press and hold clamps for Picatinny rail scope mount.
5. Pivot the Picatinny rail scope mount from right to left. Turn the scope mount from the receiver and remove it (Fig. 42).

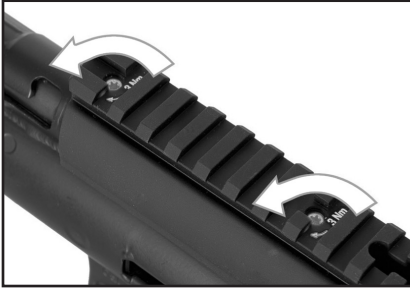

Fig. 41 – Loosen screws

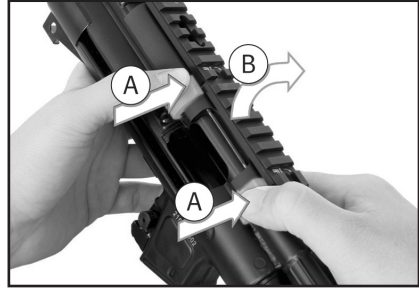

Fig. 42 – Remove Scope Mount

End of recommended disassembly procedure

Further disassembly, including disassembly of the pistol grip and the trigger mechanism is not necessary or recommended. For more information, please contact HK Customer Service.

MAGAZINE MAINTENANCE

NOTE: The SP5 Series pistol uses 30, 15, or 10-round capacity 9 mm magazines designed for use in HK MP5, HK94, and related models. Use of HK manufactured magazine is recommended.

Disassembly of magazines

Disassembly of magazines for maintenance is not necessary. Light lubrication for corrosion protection should be the only maintenance required..

SECTION 9 ASSEMBLY

Install Picatinny rail scope mount (normally already installed on the SP5K)

Required materials: Torque wrench 3 Nm/.67 pounds-force, Torx insert TX15

1. Place scope mount against receiver (Fig. 43).
2. Depress both scope mount clamps simultaneously and pivot the scope mount onto receiver until the clamps on the SP5K's mounting points click into place (Fig. 43).
3. Set the torque setting of 3 Nm/.67 pounds-force (lbf).
4. Place Torx insert in torque wrench.
5. Tighten screws for Picatinny rail clockwise with torque wrench until the torque is reached (Fig. 44).

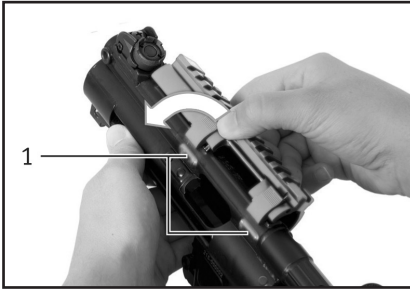

Fig. 43 – Install Picatinny rail scope mount

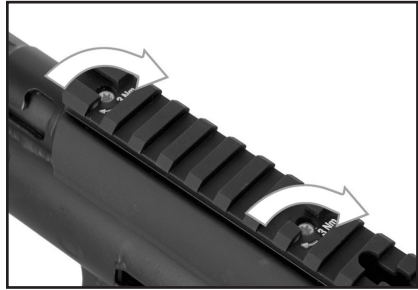

Fig. 44 – Tighten screws

Assemble bolt group

1. Push pressure spring for firing pin onto firing pin (Fig. 45).
2. Place firing pin with pressure spring for firing pin into bolt head carrier (Fig. 45)
Observe assembly position of locking piece (Fig. 46).
3. Press locking piece completely into bolt head carrier and hold it.
4. Turn locking piece anti-clockwise until assembly position has been reached (Fig. 46).
5. Place bolt head with extractor upwards Ⓐ onto locking piece (Fig. 47).
6. Turn bolt head counter-clockwise Ⓑ until the connecting piece audibly and tangibly snaps into place (Fig. 47).

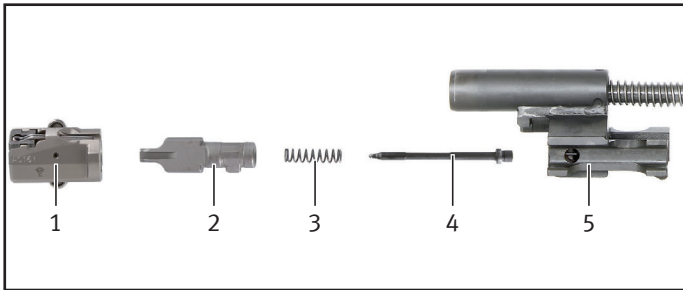

Fig. 45 – Assemble bolt group

- | | |
|----------------------------------|---------------------|
| 1 Bolt head | 4 Firing pin |
| 2 Locking piece | 5 Bolt head carrier |
| 3 Pressure spring for firing pin | |

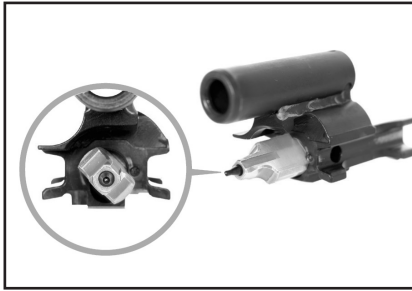

Fig. 46 – Assembly position for locking piece

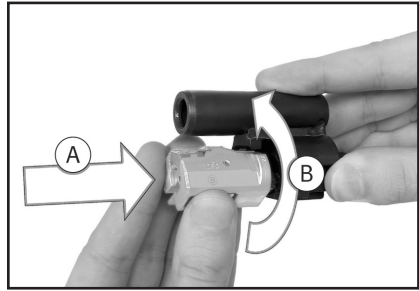

Fig. 47 – Insert bolt head

Assemble the assembly groups

1. Assemble bolt group.
2. Place handguard onto receiver from below and press it rearwards (Fig. 48).
3. Push locking pins for handguard into receiver. Locking pins can be pushed in from either side of the receiver.
4. Insert bolt group and recoil spring into receiver from the rear (Fig. 49).
5. Insert pistol grip into receiver and rotate upwards (Fig. 50).
6. Insert back plate into receiver.
7. Push locking pins for back plate into receiver (Fig. 51). Locking pins can be pushed in from either side of the receiver.

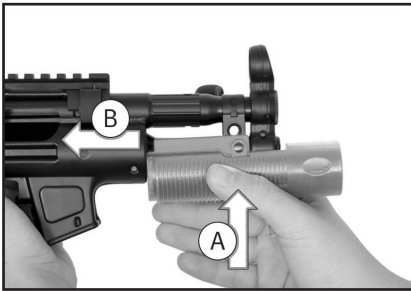

Fig. 48 – Install handguard

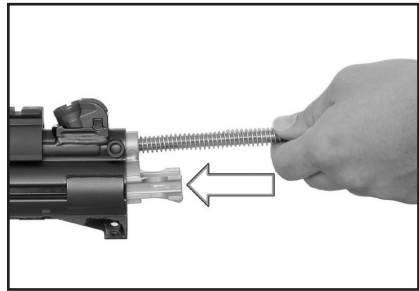

Fig. 49 – Insert bolt group and recoil spring



Fig. 50 – Insert pistol grip

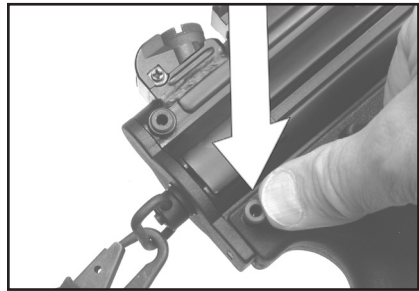

Fig. 51 – Insert locking pins

FUNCTION CHECK

It is essential that a function check be performed on the pistol after reassembly to ensure that the firearm's components have been correctly installed.

1. After assembling the gun, pull the cocking lever to the rear and release.
2. Put the selector on "SAFE" and pull the trigger. The pistol should not fire.
3. Put the selector on "FIRE" and pull the trigger. The hammer should fall.
4. Keep the trigger pulled to the rear and cycle the cocking lever.
5. Release the trigger to ensure that the trigger will reset.
6. Repeat several time to make certain the pistol functions correctly.

Contact the Heckler & Koch Customer Service Department at TEL: 706-568-1906 or EMAIL: cs@heckler-koch-us.com if you encounter any problems in attempting to disassemble, assemble, and/or conduct a function check on the SP5 Series pistols.

CLEANING

NOTE: The service life and performance of your HK SP5 Series pistol is dependent upon the correct handling and proper care by the operator.

Materials Required - Many commercially available firearms cleaning kits should be functional for cleaning and maintaining the SP5 Series pistol. At a minimum, we suggest the following materials to properly clean a SP5 Series pistol:

- Cleaning rod with handle and patch holder
- Nylon toothbrush
- Bronze bristle bore brush (in the appropriate caliber)
- Cleaning patches (in the appropriate caliber)
- Lint-free wiping rag
- Cleaning solvent/lubricant
- Cotton swabs

CAUTION: Use safety goggles when using solvents and exercise care if using compressed air.

Regular cleaning and care of the SP5 Series pistol and accessories

- maintain functional reliability,
- increase service life,
- prevent accidents, and
- save repair costs and time.

Clean the pistol each time it is fired and at intervals of 1000 rounds. The pistol should also be thoroughly cleaned when the pistol is exposed to, or laden throughout, with sand, dust, water (especially salt water) or other visible contaminants or foreign matter.

NOTE: Risk of material damage from the use of excessive force! The use of excessive force during cleaning can damage the SP5 Series pistol. Do not use excessive force when cleaning the pistol.

WARNING! Risk of injury from improperly assembled SP5 Series pistol! Improper assembly can compromise the safety and functioning of the SP5 Series pistol. Only disassemble the pistol to the extent described in this manual.

Slide -

- Gently scrub all internal surfaces of the slide using the nylon toothbrush moistened with solvent.
- Remove all loose fouling from all surfaces of the slide using a rag and cotton swabs.

Recoil spring assembly -

- Remove all visible fouling using solvent, a nylon toothbrush or a rag and cotton swabs.

Barrel (with locking block) -

- Moisten a bronze bore brush with solvent and scrub the bore from chamber to muzzle at least six (6) passes, back and forth.
- Remove the loose fouling from the bore using cleaning patches.
- Gently scrub the exterior of the barrel and locking block with the nylon toothbrush moistened with solvent.

- Remove all loose fouling from the exterior of the barrel using a rag and cotton swabs.

Frame -

- Gently scrub all internal surfaces where carbon fouling is present using the nylon toothbrush moistened with solvent. Concentrate on the area normally covered by the slide.
- Using a rag and cotton swabs, remove all loose fouling from all areas of the frame.

Magazine -

- Gently scrub the top of the magazine, concentrating on the follower and feed lips, using the nylon toothbrush moistened with solvent.
- Using a rag and cotton swabs, remove all loose fouling from all surfaces of the magazine.

Major Cleaning - Major Cleaning is the same as normal cleaning except that:

- The magazine is disassembled for cleaning.
- All parts should be rinsed with or immersed in solvent and thoroughly scrubbed with a nylon brush. The parts can then be dried using compressed air or with a rag and cotton s swabs.

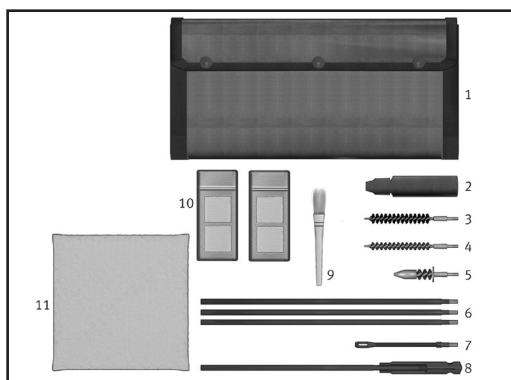

Fig. 52 – Sample cleaning kit

- | | |
|--------------------------|-----------------------|
| 1 Bag for cleaning kit | 7 Pull-through holder |
| 2 Oil bottle | 8 Handle rod |
| 3 Oil brush | 9 Cleaning brush |
| 4 Barrel cleaning brush | 10 Cleaning cloths |
| 5 Chamber cleaning brush | 11 Cleaning rag |
| 6 Extension rod (3x) | |

CLEAN SP5 SERIES PISTOL

1. Disassemble.
2. Clean assembly groups.
3. Clean barrel.
4. Lubricate pistol.
5. Assemble the pistol.

CLEAN ASSEMBLY GROUPS

Required auxiliary materials: cleaning rag

1. Clean fouled parts and surfaces using cleaning rag.
2. Clean inside of receiver using cleaning rag.
3. Clean pistol grip, recoil spring, firing pin and bolt head using cleaning rag.
4. Clean firing pin bore in bolt head using cleaning rag.
5. Clean magazine well, magazine and follower using cleaning rag.
6. Visually check SP5 Series pistol for damage.

CLEAN BARREL

Required auxiliary materials: Oil, cloth cleaning pull-throughs, cleaning kit

1. Screw together handle rod, extension rods and chamber cleaning brush.
2. Clean chamber and locking piece using chamber cleaning brush.
3. Replace chamber cleaning brush with barrel cleaning brush.
4. Pull lubricated barrel cleaning brush through the barrel several times. To protect the barrel crown, it is recommended inserting the brush from the chamber to the muzzle.
5. Replace barrel cleaning brush with pull-through holder.
6. Insert clean cleaning pull-throughs in pull-through holder.
7. Pull clean cleaning pull-throughs through barrel several times until barrel is free of oil and foreign bodies.
8. Replace cleaning pull-through with oil brush.
9. Pull lubricated oil brush through barrel.

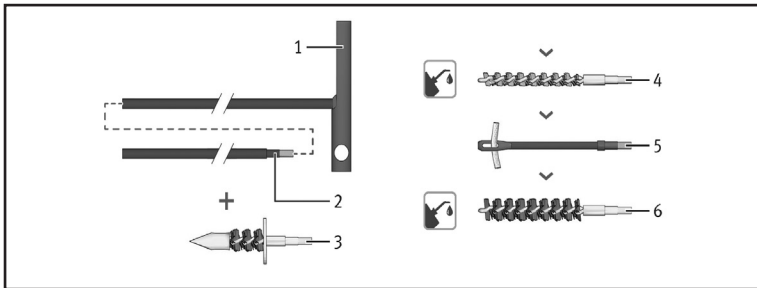

Fig. 53 – Sample cleaning kit components

- | | |
|--------------------------|-------------------------|
| 1 Handle rod | 4 Barrel cleaning brush |
| 2 Extension rod | 5 Pull-through holder |
| 3 Chamber cleaning brush | 6 Oil brush |

NOTE: Risk of material damage from incorrect cleaning direction! Cleaning the barrel from the muzzle end may damage the muzzle. A damaged muzzle will decrease the pistol's accuracy. Always clean the barrel starting from the chamber end.

LUBRICATION

Required auxiliary materials: Oil

1. Lubricate cleaned metal parts thinly.
2. Lubricate lubrication points of bolt group (Fig. 54).
3. Lubricate lubrication points on pistol grip (Fig. 55).
4. Lubricate lubrication points of functional elements (Fig. 56).
5. Lubricate outside of magazine thinly.

NOTE: Risk of material damage from lubricated cartridges! Lubricated cartridges result in increased loads on components and can damage the SP5 Series pistols. Do not lubricate the inside of the magazine.

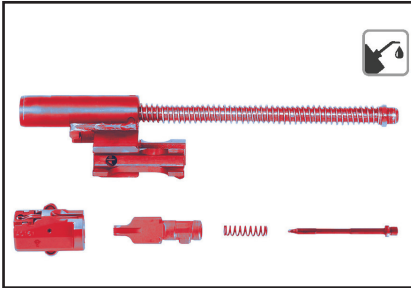

Fig. 54 – Lubrication points of bolt group



Fig. 55 – Lubrication points on pistol grip



Fig. 56 – Lubrication points of functional elements

CAUTION: Do not use a stainless steel bore brush which can scratch the bore and reduce accuracy.

NOTE: All parts of SP5 Series pistols can be immersed in any cleaning solvent that is safe to put your hands into, including ultrasonic cleaning solution. Use of ultrasonic cleaning machines can result in the unwanted removal of colored reference markings of the frame, extractor and control lever (where applicable). Use of ultrasonic cleaning is normally not necessary or recommended when using standard ammunition in HK pistols with less than 10,000 rounds of service. All components should be thoroughly dried after being immersed in solvents of any kind before reassembly and all of the firearm's critical components should be lubricated in accordance with the applicable operator/maintenance instructions after being thoroughly dried. For special cleaning recommendations under extreme conditions, please contact HK Customer Service.

INSPECTION

During and after cleaning, visually inspect the pistol and its components for any irregularities that may cause problems or stoppages during operation. Generally, you should keep a watchful eye out for the discrepancies listed below.

Always clear the pistol before conducting your inspection!

Check for:

- Damaged or missing parts
- Improper assembly or function
- Absence of free movement, where applicable
- Absence of spring tension, where applicable
- Unaccustomed looseness
- Parts exhibiting signs of cracks, burrs, dents or obvious signs of damage or stress
- Presence of stops or tactile clicks, where applicable
- General overall cleanliness
- Presence of sufficient lubrication
- Presence of corrosion or degradation of surface finish.

WARNING! HK pistol designs represent an optimization of a combination of safety, speed of deployment, accuracy, dependability, and durability. Do not attempt to make an HK pistol "better" by altering any of its components. Altering any part of the pistol or magazine may cause injury or death and will also void any HK warranty on the product.

TROUBLESHOOTING PROBLEMS AND REPAIR

Common causes of problems that are often overlooked include:

- Fouled or improperly lubricated pistol
- Bad ammunition
- Damaged magazines
- Operator error

If your SP5 Series pistol still fails to function, please contact HK Customer Service at 706-568-1906 for the name and address of your nearest HK Authorized Repair Facility. Law enforcement users, contact your unit armorer or HK Customer Service.

NOTE: If after reviewing this manual you still have questions, please contact HK Customer Service at 706-568-1906 or by email: cs@heckler-koch-us.com.

SECTION 11 WARRANTY

WARRANTY REGISTRATION

New HK firearms are covered by Heckler & Koch, Inc.'s Limited Lifetime Warranty. Warranty registration is now online. To register your new HK firearm, go to: <https://hk-usa.com/warranty/registration/>

If you do not have access to the Internet, contact Heckler & Koch, Inc. to obtain a warranty registration form:

HK Customer Service
5675 Transport Boulevard
Columbus, GA 31907
Telephone: 706-701-5554.
Email: cs@heckler-koch-us.com

HECKLER & KOCH, INC. LIMITED LIFETIME WARRANTY

All new Heckler & Koch, Inc. firearms purchased after January 1, 1998, are warranted to the original retail purchaser only for the lifetime of the said original retail purchaser. In the event that this original retail purchaser, at the time of the original purchase, shall donate this firearm to another person, the donee name must be submitted during the online warranty registration. Heckler & Koch, Inc. does not guarantee or warrant that any, all, or some donations or gifts are valid and compliant with all applicable laws, regulations, and ordinances. Heckler & Koch, Inc. is not responsible or liable in any way for a donation or gift that does not comply with applicable laws, regulations, and ordinances. It is the responsibility of the original retail purchaser and the donee or recipient to ensure that any such transfer complies with all applicable laws, regulations, and ordinances. Upon completion of the online warranty registration indicating the name of the said donee, this warranty shall be extended to the lifetime of the said donee. This warranty applies only if the firearm was imported into the United States and distributed by Heckler & Koch, Inc. to an authorized dealer.

What Will We Do?

Heckler & Koch Inc. will, at its option, repair or replace without charge any HK firearm that fails due to a defect in materials or workmanship. Parts and labor are included. Repairs are warranted for the duration of the warranty. If Heckler & Koch, Inc. replaces a firearm under this warranty; you will receive a new warranty. Heckler & Koch, Inc. will return your firearm to you shipping pre-paid.

How to Obtain Service:

Contact Heckler & Koch, Inc. via phone at 706-701-5554 or email at cs@heckler-koch-us.com for a Return Authorization Number before sending your firearm freight prepaid to Heckler & Koch, Inc. at the address listed below. No C.O.D. shipments will be accepted.

Only the existing Heckler & Koch, Inc. Service Center or any other authorized Heckler & Koch, Inc. Service Center that may be established by Heckler & Koch, Inc. shall be authorized to make warranty repairs.

Return the complete, unloaded firearm with a detailed description of the problem using Heckler & Koch, Inc.'s Return Form.

DO NOT send any live ammunition with the firearm. If you must send ammunition to us for proof purposes, be sure that it is sent separately from the firearm.

We strongly recommend that you complete the online warranty registration at <https://hk-usa.com/warranty/registration/> to establish eligibility for warranty service. If you do not return an acknowledgment of online warranty registration to Heckler & Koch, Inc., you are required to provide adequate proof of the date that you purchased your new HK firearm at the time you send your firearm to Heckler & Koch, Inc. for warranty service.

In the event that this firearm was given as a gift at the time of original purchase, the online warranty registration with the name of the donee must be provided to Heckler & Koch Inc., in order for the warranty to become effective.

Note: Non-warranty servicing must follow the same shipping procedures as stated above. HK firearms with a valid Return Authorization Number should be shipped to the following address in accordance with these instructions:

HKI
Attn: Service Department/RA# _____
5675 Transport Blvd.
Columbus, GA 31907

Any information gathered in connection with a Heckler & Koch Inc. lifetime limited warranty shall be used for that purpose and may be used for other legitimate business purposes of Heckler & Koch Inc. For further information, please review Heckler & Koch, Inc.'s Privacy Policy, located at <https://hk-usa.com/cookie-policy-us/>

What Is Not Covered?

This warranty does not cover defects or damage caused by: (1) unreasonable use; (2) failure to provide proper care or maintenance; (3) failure to comply with instructions in the operator's manual including improper installation of original Heckler & Koch Inc. parts by the owner or his agent; (4) normal wear and tear for the degree of use; (5) rust or corrosion; (6) obstructions in the barrels; (7) excessive use; and/or (8) external and internal cosmetic finishes.

Heckler & Koch, Inc. reserves the right to determine what constitutes the unreasonable or excessive use of the firearm. All wooden parts and all accessories are excluded from warranty coverage.

This warranty does not cover any claims made by the second or subsequent owner of an HK firearm as stated above.

NOTICE Any unauthorized alteration or modification of the firearm or use of parts or components not originally made by Heckler & Koch, Inc. may void this warranty. Heckler & Koch, Inc. is not be responsible for any claims involving this firearm that result from the use of faulty, nonstandard, remanufactured, or reloaded ammunition or ammunition not manufactured to NATO, CIP, and/or SAMMI specifications.

Under no circumstances shall Heckler & Koch, Inc. be responsible or liable for incidental or consequential damages with respect to loss of use, loss of business or profits, other economic loss or injury to property, whether as a result of breach of express or implied warranty, negligence or otherwise. This Limited Lifetime Warranty applies only to retail purchases by individuals through an authorized Heckler & Koch, Inc. dealer.

Residents of CALIFORNIA, CONNECTICUT, DISTRICT OF COLUMBIA, HAWAII, MARYLAND, MASSACHUSETTS, MICHIGAN, NEW JERSEY, NEW YORK, AND U.S. TERRITORIES.

Any work involving replacement of the receiver of a firearm requires that the firearm be returned to a licensed firearms dealer. A current, signed copy of the dealer's FFL will be required. Please provide contact information for the chosen dealer, if applicable.

NOTICE Customers in restrictive capacity states: **DO NOT ship high capacity magazines to Heckler & Koch Inc. They cannot be returned.**

Exclusions

This lifetime warranty explicitly excludes firearms purchased by the United States military, government institutions or agencies of the United States or any of its constituent states and territories, law enforcement agencies of the United States or any of its constituent states and territories, and/or security organizations located within the United States or any of its constituent states and territories. Firearms purchased by these entities and organizations for duty issue to their personnel and/or employees are covered by a one-year limited warranty against material defects and workmanship or as agreed upon in a valid contract.

This lifetime warranty also excludes rimfire .22L R firearms, and all suppressors, which are covered by a one-year warranty.

Some states do not allow the exclusion or limitation of incidental or consequential damages, so the above limitations or exclusions may not apply to you. This warranty gives you specific legal rights, and you may also have other rights, which vary from state to state. This limited warranty is the only express warranty by Heckler & Koch Inc.

Heckler & Koch Inc. does not authorize any dealer or any other person to vary the terms of this warranty or make any other express warranties.

Heckler & Koch, Inc. Lifetime Barrel Guarantee

Heckler & Koch, Inc. guarantees the serviceability of the bore of the barrels of all MR A4 Series rifles and pistols for the lifetime of the original consumer purchaser for individual use. This guarantee is based on barrels meeting standards on accuracy, velocity, and useability across the entire life of the A4 system. If at any time an A4 barrel fails to meet these standards, Heckler & Koch, Inc. will replace the barrel.



Where to Get Further Help

If you have questions concerning this warranty, please contact Heckler & Koch, Inc.'s Customer Service Department at:
5675 Transport Blvd.
Columbus, GA 31907
Telephone: 706-701-5554
Email: cs@heckler-koch-us.com

SECTION 12 SP5K ACCESSORIES

RAIL MOUNTED ACCESSORIES

HK SP5K pistols have a MIL-STD-1913 (Picatinny rail) scope mount rail installed on the top of the receiver. This scope mount allows the operator to mount a wide variety of accessory scopes, sights, and aiming devices to the handgun by means of the simple and proven Picatinny interface system. (see Fig. 57).



Fig. 57 – Accessory sight module mounted on SP5K pistol

To avoid damage to the accessory and the SP5 Series pistol, carefully follow the instructions of the manufacturer for installing, operating, and removing accessories from the scope mount rail. Always ensure the pistol is “clear” and unloaded before installing or removing accessories. If encountering difficulty, please contact HK Customer Service to avoid damage to the pistol or the accessory.

Installation of some accessories can change the status of the SP5 Series pistol from civilian handgun to a Short Barrelled Rifle (SBR) or Class III firearm requiring licensing from federal and state authorities. Contact the relevant law enforcement agencies (including the U.S. BATFE) before installing accessories like buttstocks and handguard with a vertical foregrip.



Fig. 58 – Magazine loader



Fig. 59 – Magazine unloader



Fig. 60 – Spare magazines

WARNING! Improperly designed or installed accessories may result in damage to the rail system and/or the pistol. Such damage is not covered under warranty. Be certain to use only HK approved accessories and follow installation and precautions carefully.



Fig. 61 – SP5 muzzle interface

The muzzle on the SP5 pistol features two distinct retention features for muzzle mounted accessories:

1. $\frac{1}{2}$ x 28" threaded muzzle with accompanying thread protector.
2. HK's proprietary three lug engagement surfaces directly behind the muzzle.

The following steps are recommended before attempting to install any muzzle mounted accessories on the barrel of the SP5:

1. Ensure the SP5 is clear by performing a safety check.
2. Ensure any muzzle mounted accessory is compatible with the two retention features as described above.

NOTE: If after reviewing this manual you still have questions, please contact HK Customer Service at 706-568-1906 or by email: cs@heckler-koch-us.com.

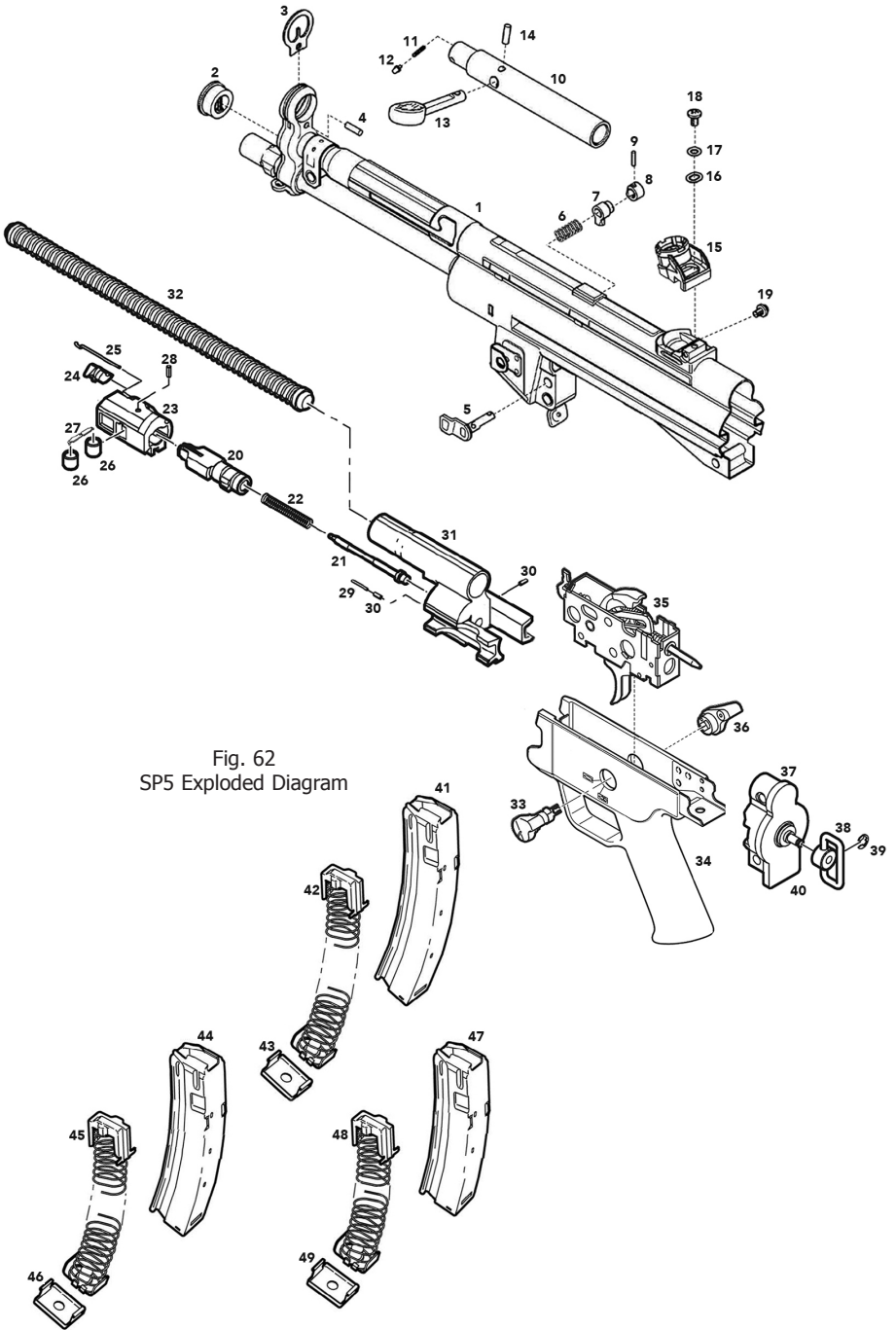
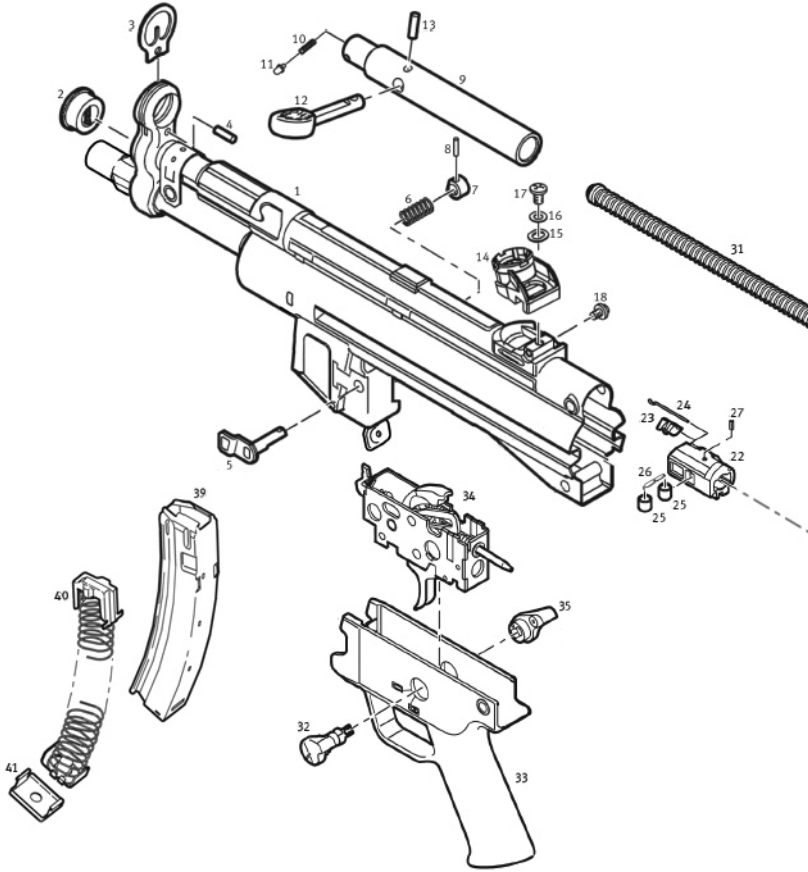

Fig. 62
SP5 Exploded Diagram

SP5 PARTS LIST & EXPLODED VIEW

Item	Description	Part Number	Item	Description	Part Number
—	Receiver SP5, compl. (Item 1-19)	253434	27	Holder for locking rollers	214333
1	Receiver SP5	253435	28	Clamping sleeve	200450
2	Cap, compl.	206497	29	Catch pin	201597
3	Front sight	200415	30	Clamping sleeve (2x)	205597
4	Clamping sleeve	922609	31	Bolt head carrier, compl.	253441
5	Magazine catch	214858	32	Recoil spring guide rod, compl.	214883
6	Pressure spring for magazine catch	200393	--	Pistol grip, compl. (Item 33 - 36)	253442
7	Pressure piece for magazine catch	201517	33	Safety lever, left	217810
8	Push button for magazine catch	200396	34	Pistol grip, finished	254200
9	Clamping sleeve for push button	922608	35	Trigger housing, compl.	250881
--	Charging handle, compl.(10 - 12)	205906	36	Safety lever, right	226289
10	Support for charging handle	205909	--	Cap, compl. (Item 37 - 39)	205933
11	Pressure spring for detent spring	202495	37	Cap	205934
12	Detent pin	205910	38	Eyelet	205935
13	Charging handle, compl.	205905	39	Circlip	929299
14	Clamping sleeve	922609	40	Locking bolt for pistol grip and cap	200520
15	Rear sight, compl.	206407	--	Magazine, compl. 30 rd (Item 41 - 43)	206349
16	Washer	200371	41	Magazine body	206305
17	Toothed washer	922617	42	Magazine spring - follower and insert ..	206676
18	Screw for rear sight	200372	43	Floor plate	201654
19	Windage adjustment screw	200384	--	Magazine, compl. 15 rd (Item 44 - 46)	206477
--	Bolt group, compl. (Item 20 - 22)	253440	44	Magazine body	206478
20	Locking piece	201599	45	Magazine spring - follower and insert ..	206477
21	Firing pin	201600	46	Floor plate	201654
22	Firing pin spring	214327	--	Magazine, compl. 10 rd (Item 47 - 49)	239257
--	Bolt head, compl. (Item 23 - 28)	214412	47	Magazine body	239321
23	Bolt head	-----	48	Magazine spring - follower and insert ..	206678
24	Extractor	214414	49	Floor plate	201654
25	Extractor spring	206645	--	Handguard	206657
26	Locking roller (2x)	200446			

SP5K-PDW EXPLODED VIEW & PARTS LIST



Item	Description	Part Number	Item	Description	Part Number
—	SP5K-PDW (Item 1 - 41).....	81000481	15	Washer	200371
1	Receiver, compl. (Item 1 - 18)	250832	16	Toothed lock washer	922617
2	Cap, compl.	206497	17	Clamping screw for rotary rear sight	200372
3	Front sight	200415	18	Windage adjustment screw	200384
4	Clamping sleeve	922609	—	Bolt group, compl. (Item 19 - 31)	226387
5	Magazine catch	214858	19	Locking piece	224786
6	Compression spring for magazine catch	200393	20	Firing pin	201600
7	Push button for magazine catch	200396	21	Firing pin spring	214327
8	Clamping sleeve for push button	922608	—	Bolt head, compl. (Item 22 - 27)	214412
—	Cocking lever support, compl. (Item 9 - 11)	206423	22	Bolt head	217418
9	Cocking lever support	206410	23	Extractor	214414
10	Compression spring for cocking lever ...	206397	24	Extractor spring	206645
11	Catch bolt	206622	25	Locking roller, Ø 8 mm (2x)	200446
12	Cocking lever, compl.	205905	26	Holder for locking rollers	214333
13	Clamping sleeve	922609	27	Clamping sleeve	200450
14	Rear sight, compl.	206407	28	Catch pin	201597
			29	Clamping sleeve (2x)	205597

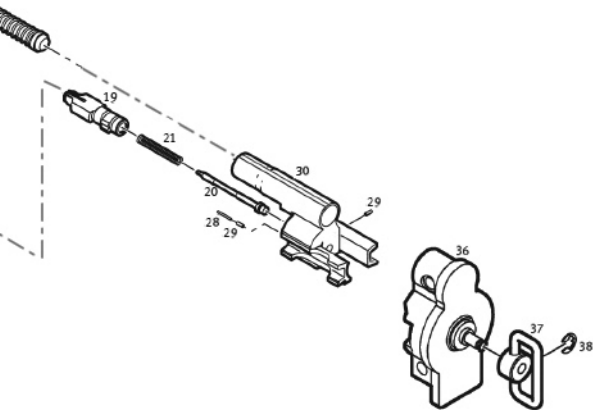

Fig. 63
SP5K-PDW Exploded Diagram

Item	Description	Part Number	Item	Description	Part Number
30	Bolt head carrier, compl.	226388	-	Magazine, complete, 10 rounds.....	239257S
31	Recoil spring guide rod, compl.	206400	-	Magazine body.....	239321
-	Pistol grip, compl. (Item 32 - 35)	254814	-	Magazine spring with follower and insert	206678
32	Safety axle, compl.	225526	-	Floor plate	201654
33	Pistol grip, finished (0-1)	239225	-	Elastic carrying sling.....	984515
34	Trigger housing, compl.	250881			
35	Safety lever	225089			
-	Cap, compl. (Item 38 - 40)	206409			
36	Cap	206416			
37	Eyelet	205935			
38	Circlip	929299			
-	Magazine, complete, 30 rounds (Item 42 - 44)	206349S			
39	Magazine body.....	206305			
40	Magazine spring with follower and insert	206676			
41	Floor plate	201654			



HECKLER & KOCH
5675 Transport Boulevard
Columbus, Georgia 31907
United States of America
Tel: (706) 568-1906
Fax: (706) 568-9151
USA Website: www.hk-usa.com