

P2000 & P2000SK OPERATOR'S MANUAL



HK
HECKLER & KOCH

Covers P2000 and P2000SK pistols
(all calibers and variants)

SAFETY RULES

Please read this operator's manual before handling your firearm. The following safety rules are placed in this manual by HK as an important reminder that firearm safety is your responsibility. Firearms can be dangerous and can potentially cause serious injury, damage to property or death, if handled improperly.

1. Never point a firearm at anyone or in any direction other than a SAFE direction, i.e. down range.
2. Treat all firearms as if they are always loaded.
3. Keep your finger off the trigger and outside of the trigger guard until your sights are aligned on the target and you are ready to fire.
4. Keep your finger off the trigger and outside of the trigger guard while loading or unloading the firearm.
5. Keep your finger off the trigger and outside of the trigger guard while pulling the firearm out of the holster or while returning it to the holster.
6. Be sure of your target and the backstop beyond.
7. Never give a firearm to or take a firearm from anyone unless the action is open and the magazine and/or chamber are free of any ammunition or brass.
8. Be sure that the ammunition you are using is factory loaded, is of the correct caliber for the firearm in which it is to be used, and that it is not damaged in any way.
9. Before firing, remove the magazine from the firearm, lock the action open, make sure the chamber is clear of any ammunition or brass, and check the barrel of the unloaded firearm for any possible obstructions.
10. Before firing any firearm that is unfamiliar to you, make sure that you understand exactly how it functions. A lack of familiarity with the firearm can result in serious accidents. Attend a certified training course on any firearm which you intend to use or with which you are not sufficiently familiar.
11. Always wear hearing and eye protection when using your firearm.
12. Keep all body parts, especially the hands and fingers, away from the muzzle to avoid injury or burns.
13. Be sure that no part of either hand touches or interferes with the slide. The slide is moved backward by the recoil force of the pistol during firing and may cause serious injury.
14. Firearms should be locked and stored separately from ammunition and beyond the reach of children and/or any untrained individuals.
15. Avoid the use of any alcoholic beverages or drugs before or during your use of a firearm.
16. Discharging firearms in poorly ventilated areas, cleaning firearms, or handling ammunition may result in exposure to lead; a substance known to be associated with birth defects, reproductive harm and other serious injury. Have adequate ventilation at all times. Wash hands thoroughly after exposure.

STOP! Know how to clear this pistol before attempting to operate.

Clearing the Pistol - The HK Pistol is not considered "clear" or safe unless:

1. The safety/control lever (if present) is on "SAFE" and;
2. The magazine is removed from the pistol;
3. The slide is locked to the rear and;
4. The chamber is free of brass or ammunition.

To Clear the HK Pistol:

1. Make sure fingers are outside of the trigger guard and the pistol is pointed in a safe direction at all times!
2. Remove magazine. Depress the magazine release lever and remove the magazine from the pistol.
3. Open and lock slide. While pointing the pistol in a safe direction, lock the slide open by pulling the slide rearward as you press the slide release upward. Watch for a cartridge or empty case to be ejected from the pistol.
4. Inspect chamber. Inspect chamber for the presence of a cartridge or empty case by:
 - Visually viewing chamber through open ejection port.
 - Physically inserting finger into chamber through ejection port to check for the presence of a cartridge or empty case.
 - Remove any cartridges or empty cases from the chamber or from within the pistol.

The HK Pistol is now considered "Clear."

WARNING: A firearm has the capability of taking your life or the life of someone else! Be extremely careful with your firearm. An accident can occur at anytime and is almost always the result of not following basic safety rules.

P2000 & P2000 SK OPERATOR'S MANUAL



Covers P2000 & P2000SK pistols (all calibers and variants)

HECKLER & KOCH
5675 Transport Boulevard
Columbus, Georgia 31907 USA
Tel: (706) 568-1906 • Fax: (706) 568-9151
USA Website: www.hk-usa.com

© Heckler & Koch USA (Heckler & Koch Inc. and Heckler & Koch Defense Inc.) May 2026
All rights reserved. Specifications and models subject to change without notice.

TABLE OF CONTENTS

Safety Precautions & Clearing	Inside Cover
Section 1 Introduction.....	5
Section 2 Nomenclature	10
Specifications	11
Section 3 Function & Operation	12
Clearing	12
Operating Controls & Components	13
Sights & Sight Adjustment	14
Section 4 Ammunition	15
Section 5 Instructions for Use	16
Filling & Emptying the Magazine	16
Loading	16
Firing	17
Unloading	17
Selection & Use of a Holster	18
Storage & Transport	18
Interchangeable Backstraps	19
Section 6 Disassembly & Assembly	21
Magazine Disassembly	24
Magazine Assembly	25
Section 7 Cleaning & Maintenance	26
Inspection	27
Lubrication	27
Troubleshooting Problems & Repair	28
Warranty Registration Information	28
HK Lock-Out Device	32
Accessories	33
Section 8 P2000 Parts List	36
Exploded View	37
Parts List - P2000SK	38
Exploded View	39
Firearms Service Record	40

The P2000 and P2000SK (Subcompact) incorporate features of the successful Heckler & Koch USP Compact pistol with later innovations of HK engineers. A refinement of a design created for several European police agencies, the P2000 and P2000SK are available with a traditional double-action/single-action trigger mode and the LEM (Law Enforcement Modification) trigger system first introduced by HK in 2001 on the USP Compact “LEM” model.

The P2000 and the P2000SK were among the HK pistols subjected to the most punishing pistol evaluation to date undertaken by the U.S. Department of Homeland Security’s Immigration and Customs Enforcement branch. The evaluation was performed with the most potent ammunition loads for three calibers (9 mm, .40 S&W and .357 SIG).

After three million rounds were fired, HK candidate pistols finished ahead of five other competing manufacturers, earning a “Superior” technical rating. On August 20, 2004, HK was awarded the largest pistol contract in U.S. law enforcement history. Five months later, U.S. Customs and Border Protection (CBP), the largest U.S. federal law enforcement agency, officially adopted the P2000 pistol in .40 S&W.

Most of those HK P2000 and P2000SK pistols use the HK Law Enforcement Modification (LEM) trigger system (also known as the Combat Defense Action system in Europe). The LEM trigger system combines the advantages of a cocked striker component (constant level of trigger pull from first to last round fired) with a double-action hammer system.

Using such an enhanced trigger system consolidates ease of use and safety into a convenient, innovative trigger operation—one that reduces the chance of unintended firing. And in case of an ammunition-related failure to fire, all that is needed is an additional second or third squeeze of the trigger without the need of first pulling the slide back to re-cock the pistol. The enhanced LEM trigger system combines the reliability of a double action revolver trigger with the crisp trigger of a single action pistol.

On P2000 and P2000SK variants using the conventional double-action/single-action (DA/SA) mode of operation, an ambidextrous decocking button is mounted on the left, rear portion of the frame. It allows the user to safely lower the hammer from SA position to DA position. This DA/SA variant of the P2000 and P2000SK is readily identifiable by the presence of the serrated decocking button and spurred hammer.

The addition of “industry standard” mounting rails to the P2000 and P2000SK allows the widest variety of lights, aimers, and accessories to be added by sliding them onto the open rail system. The HK P2000 uses widely available, reliable, steel USP Compact magazines. The same magazines fit the P2000SK for added firepower, but extend past the edge of the grip portion of the frame.

A set of easy-to-install modular backstraps allow the P2000 and P2000SK pistols to be custom-fitted to any shooter’s hand. Ambidextrous slide release levers and magazine release levers make handling the P2000 Series pistol natural and easy for right and left-handed shooters. P2000 and P2000SK pistols are currently available in .40 S&W, and 9 mm.

P2000 / P2000SK pistols use a modified Browning-type action, much like the HK USP and USP Compact. And like the USP and USP Compact, these pistols also use a similar mechanical recoil reduction system. This system includes a specially designed flat recoil spring, contained in the captive recoil spring assembly by an absorber bushing made of a high-strength polymer. The double recoil/buffer spring assembly used on P2000SK performs the same function.

Significant P2000 and P2005K features include:

- Exchangeable backstraps to easily adjust the grip size to the shooter's hand
- Ideal size and weight to comply with the requirements of the full range of police and security missions, including concealed carry
- Set of "industry standard" mounting grooves molded into the polymer frame for installing accessory lights and laser aimers
- Advanced design with contoured external surfaces to avoid snagging on holster and clothing
- Polymer recoil absorber "stop" bushing used on P2000 in recoil reduction, double recoil/buffer spring assembly used on P2005K
- Ambidextrous slide release (located on both sides of the frame)
- Ambidextrous magazine release
- Low-profile slide and slimline, compact dimensions
- Very short trigger reset distance to enhance the speed of multiple or follow-up shots
- No snag hammer (on LEM models) with a rubber insert for improved dropped safety
- Polygonal cold-hammer forged barrel for less barrel wear, better gas seal behind the bullet, and easier bore cleaning

The polymer frame of the P2000 Series pistol was designed using technical experience gained by HK engineers in the development of the world's first composite material pistols, the HK VP70Z and P9S (polymer outer frame/steel internal frame), and more recently, in the USP/USP Compact, HK45/HK45 Compact, P30 series, and VP series pistols. These same high-strength/corrosion-free materials are also used in the Mark 23/MK 23 handgun made by HK for the U.S. Special Operations Command. Major metal components like the one-piece, machined steel slide are also corrosion resistant and treated with a special "HE" (Hostile Environment) protective finish. The HE finish is an extremely hard, nitro-gas carburized black oxide coating which resists much of the worst types of corrosion and wear, including limited exposure to salt water.

Law Enforcement Modification

This unique pre-cocked hammer system combines the advantages of a cocked striker component (constant level of trigger pull and short trigger travel from first to last round fired) with the double-action hammer system. This ensures an extremely safe pistol with regard to unintended firing and, in case of failure to ignite, the possibility of a second or third trigger pull without the need of first pulling the slide back to re-cock the system. This is an advantage over many striker-fired trigger systems which need to be manually re-cocked (slide pulled back) before the trigger can be pulled.

Law Enforcement Modification (LEM) Variant 2 (V2), Firing Double-action only mode - (Hammer uncocked)

1. Aim - Aim at the target.
2. Fire - Fire the pistol by pressing the trigger straight to the rear with gradually increasing pressure.

NOTE: The P2000 and P2005K models with LEM trigger systems fire in a Double-Action Only mode and its hammer will automatically return to the uncocked position (or pre-cocked) each time the slide returns to its forward position and the trigger is released.

P2000 Series pistols fitted with the Law Enforcement Modification (LEM) trigger operate much like standard Double-Action Only (DAO) variants of the USP and USP Compact pistols. However, the way in which the LEM hammer is cocked is unique. The hammer in the LEM is a two-piece hammer comprised of a cocking piece (not visible with the pistol assembled) and an external (visible) bobbed hammer.

In the LEM system, the quality of the trigger pull is improved, while at the same time a stronger hammer spring can be employed to improve reliability by increasing the firing pin indent on the primer. The stronger hammer spring also helps to reduce the slide velocity when firing "hot" ammunition.

P2000 and P2000SK pistols with an LEM trigger system use the rearward movement of the slide during loading or firing to fully compress the hammer spring instead of relying on the rearward pull of the trigger as in conventional DA or DAO systems.

The cocking piece and hammer are rotated rearward on the hammer axle when the slide moves fully rearward. When fully to the rear, the cocking piece is held in the cocked position by the sear and the hammer spring has been fully compressed by the hammer strut. As the slide travels forward, the hammer is rotated back and held in the forward position by the catch.

When the trigger is pulled rearward against the combined force (at approximately 7.3 – 8.5 pounds new, approximately 4.5 pounds on "light" pull variants) of the trigger, hammer rebound, firing pin block and sear springs, the internal passive safeties are disengaged and the sear releases the cocking piece. The cocking piece is then free to rotate the hammer forward on its axle, under pressure of the compressed hammer spring, imparted through the hammer strut to strike the firing pin and fire the chambered round.

Double Action/Single Action Variant 3 (V3)

Firing the Single-Action (SA) Mode Pistol – (Hammer cocked, DA/SA variant)

1. Aim – Aim at the target.
2. Fire – Fire the pistol by pressing the trigger straight to the rear with gradually increasing pressure.

Firing the Double-Action (DA) Mode – (Hammer uncocked, DA/SA variant)

1. Engage Decocking Lever – Apply forward pressure to the serrated surface of the decocking lever. This allows the hammer to safely assume the uncocked position.
2. Aim – Aim at the target.
3. Fire – Fire the pistol by pressing the trigger straight to the rear with gradually increasing pressure.
4. Decock – Engage decocking lever to return to the double-action mode. The P2000 Series DA/SA variant will revert to the single-action mode on each shot unless the operator physically decocks the hammer by way of the decocking lever.

On the double-action/single-action variant, pulling the trigger will cock the hammer and immediately release it firing the first chambered cartridge. All subsequent cartridges will be fired in the single-action mode because the slide automatically recocks the hammer after each shot is fired.

Unloading the Pistol - To unload the pistol, follow the "Clearing" procedure.

Clearing the Pistol - HK P2000 Series pistols are not considered "clear" or safe unless:

1. The magazine is removed from the pistol.
2. The slide is locked to the rear.
3. The chamber is free of brass or ammunition.

To Clear the HK P2000 Series pistol:

1. Make sure fingers are outside of the trigger guard and the pistol is pointed in a safe direction at all times!
2. Remove magazine - Depress the magazine release lever and remove the magazine from the pistol.
3. Open and lock slide - While pointing the pistol in a safe direction, lock the slide open by pulling the slide rearward as you press the slide release upward. Watch for a cartridge or empty case to be ejected from the pistol.

4. Inspect chamber - Inspect chamber for the presence of a cartridge or empty case by:
- Visually viewing chamber through open ejection port.
 - Physically inserting finger into chamber through ejection port to check for the presence of a cartridge or empty case.
 - Remove any cartridges or empty cases from the chamber or from within the pistol.

The HK Pistol is now considered "Clear."

Double-action/Single-action Modes (P2000 Series pistol) - The P2000 Series DA/SA variant (designated a Variant 3) is configured with a combination double-action/single-action mode of operation. The P2000 Series DA/SA variant is not equipped with the LEM trigger mechanism.

In the single-action mode, rearward movement of slide cocks the hammer. Initially, this occurs by pulling the slide to the rear. Serrations cut on both left and right sides of the rear of the slide aid the operator by providing a firmer gripping surface. Chambering of the first round occurs by either depressing the slide release when the slide is locked back to the rear or by pulling the slide to the rear and releasing it. After the first round of the magazine is chambered then discharged, all subsequent cartridges will be fired in the single-action mode again due to the rearward movement of the slide passing over and cocking the hammer. In the double-action mode, pulling the trigger will cock the hammer and immediately release it firing the first chambered cartridge. All subsequent cartridges will be fired in the single-action mode because the slide automatically recocks the hammer after each shot fired.

Decocking Lever (P2000 Series DA/SA Variant 3) - P2000 Series DA/SA variants are equipped with a decocking lever that allows the operator to safely lower the hammer without having to engage the trigger. The pistol will now function and fire in the double-action mode, however; all subsequent shots will be single action. The decocking lever is located on the rear of the frame to the left of the hammer and is activated by simply applying forward pressure on the serrated surface (see Figure 1). It allows the user to lower the hammer from SA position to DA position. This variant of the P2000 Series is readily identifiable by the presence of the serrated lever (see Figure 2).



Figure 1

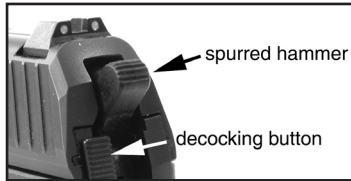

Figure 2

Another unique feature making the P2000 Series pistol truly ambidextrous is the presence of a slide release on both sides of the frame. These slide release levers are positioned to allow easy actuation without adjustment of the grip of the shooting hand and are easily removed during operator disassembly.

NOTE: On the P2000 and P2005K, the right-side slide release must be rotated up to 45° to remove.

Low-profile 3-dot sights are standard on the P2000 Series pistol. The rear sight is drift adjustable for windage. Elevation changes can be made by replacing the front sight blade with an accessory sight of a different height.

The P2000 Series pistol uses metal magazines to minimize the grip size. These magazines have a series of viewing holes on the back side for counting the cartridges remaining inside. An extended magazine floorplate with a durable finger extension is provided on each pistol's magazine. Floorplates on all magazines can be removed for cleaning and maintenance. The polymer floorplate offers a level of protection to the magazine if dropped.

WARNING: P2000 Series pistols, except special models with a magazine disconnect feature installed, will fire if the magazine is removed, a cartridge is in the chamber, and the trigger is pressed.

To reduce barrel wear, the P2000 Series pistols have polygonal, cold-hammer forged barrels. This feature not only ensures longer barrel life and easier bore cleaning, but produces a better gas seal behind the bullet for increased muzzle velocity.

A set of industry standard mounting grooves for installing accessories is molded in the polymer frame. These grooves allow many accessories and targeting devices to be mounted on the P2000 Series pistols without modification to the pistol.

NOTE: Improperly designed or installed accessories may result in damage to the mounting grooves and/or the pistol. Such damage is not covered under the limited lifetime warranty. Be certain to use only HK authorized accessories and follow installation and precautions carefully.

P2000 Series pistols are extremely safe firearms with both passive and active safeties. The user activated HK Lock-Out Device is also installed on P2000 Series pistols (see page 30 for more information on this feature). Safe, simple to field strip and maintain, P2000 Series pistols are reliable and trouble-free handguns.

SECTION 2 NOMENCLATURE



Figure 3 — P2000 (left side view)



Figure 4 — P2000SK (right side view)

P2000 SPECIFICATIONS

Caliber	.40 S&W, .357 SIG	9 mm x 19
Operating Principle	Short recoil, modified	Short recoil, modified
Action Type	Browning type, linkless	Browning type, linkless
Sights	Three dot, fixed patridge style, drift adjustable	Three dot, fixed patridge style, drift adjustable
Total Length	173 mm (6.81 in.)	173 mm (6.81 in.)
Barrel Length	93 mm (3.66 in.)	93 mm (3.66 in.)
Barrel Profile	Six-sided polygonal	Six-sided polygonal
Sight Radius	142 mm (5.59 in.)	142 mm (5.59 in.)
Twist Length	250 mm (9.84 in.)	250 mm (9.84 in.)
Overall Height (with magazine inserted)	138 mm (5.43 in.)	138 mm (5.43 in.)
Overall Width	34 mm (1.34 in.)	34 mm (1.34 in.)
Weight (with empty magazine)	765 grams (27 oz.)	709 grams (25 oz.)
Weight of empty magazine	85 grams (3 oz.)	85 grams (3 oz.)
Magazine Capacity	10 / 12 cartridges	10 / 13 cartridges
Safety Features	(1) Double-action mode with hammer intercept notch, (2) Firing pin block, (3) Disconnecter, (4) Drop safety, (5) Lock-out device, (6) Optional magazine disconnect	
Variant 2 (V2)	Law Enforcement Modification (LEM) enhanced DAO	
Variant 3 (V3)	Double Action/Single Action (DA/SA) with Decocker	

P2000 SK SPECIFICATIONS

Caliber	.40 S&W, .357 SIG	9mm x 19
Operating Principle	Short recoil, modified	Short recoil, modified
Action Type	Browning type, linkless	Browning type, linkless
Sights	Three dot, fixed patridge style, drift adjustable	Three dot, fixed patridge style, drift adjustable
Total Length	163 mm (6.42 in.)	163 mm (6.42 in.)
Barrel Length	83 mm (3.27 in.)	83 mm (3.27 in.)
Barrel Profile	Six-sided polygonal	Six-sided polygonal
Sight Radius	132 mm (5.20 in.)	132 mm (5.20 in.)
Twist Length	250 mm (9.84 in.)	250 mm (9.84 in.)
Overall Height (with magazine inserted)	117 mm (4.61 in.)	117 mm (4.61 in.)
Overall Width	36 mm (1.28 in.)	36 mm (1.28 in.)
Weight (with empty magazine)	730 grams (25.8 oz.)	675 grams (23.8 oz.)
Weight of empty magazine	75 grams (2.65 oz.)	75 grams (2.65 oz.)
Magazine Capacity	9 cartridges	10 cartridges
Safety Features	(1) Double-action mode with hammer intercept notch, (2) Firing pin block, (3) Disconnecter, (4) Drop safety, (5) Lock-out device, (6) Optional magazine disconnect	
Variant 2 (V2)	Law Enforcement Modification (LEM) enhanced DAO	
Variant 3 (V3)	Double Action/Single Action (DA/SA) with Decocker	

Specifications and models subject to change without notice.

CLEARING

WARNING: Always clear the pistol before handling it.

Clearing the Pistol - The P2000 Series pistol is not considered “clear” or safe unless:

1. The magazine is removed from the pistol;
2. The slide is locked to the rear and;
3. The chamber is free of brass or ammunition.

To Clear the HK P2000 Series pistol:

1. Make sure fingers are outside of the trigger guard and the pistol is pointed in a safe direction at all times!
2. Remove magazine. Depress the magazine release lever and remove the magazine from the pistol.
3. Open and lock slide. While pointing the pistol in a safe direction lock the slide open by pulling the slide rearward as you press the slide release upward. Watch for a cartridge or empty case to be ejected from the pistol.
4. Inspect chamber. Inspect chamber for the presence of a cartridge or empty case by:
 - Visually viewing chamber through open ejection port.
 - Physically inserting finger into chamber through ejection port to check for the presence of a cartridge or empty case.
 - Remove any cartridges or empty cases from the chamber or from within the pistol.

The P2000 Series pistol is now considered “Clear.”

General - (Refer to Figures 3 & 4 for the location of the features described below.)

Heckler & Koch P2000 Series pistols are recoil operated and use a modified Browning-style system, without a link, to lock and unlock the barrel.

Upon firing, the pressure developed by the propellant gases forces the slide and barrel assembly to the rear. After moving approximately 3mm, the locking block will stop the rearward movement of the barrel. The barrel is pulled downward due to the engagement of the angled locking surfaces of the locking block with those located on the end of the recoil spring guide rod. The locking block disengages from the slide and the slide continues rearward independently from the barrel. The extractor, located on the right side of the slide, extracts the spent case. The ejector, positioned in the left side of the frame rearward of the magazine, will then eject the fired cartridge case. The rearward moving slide then cocks the hammer and compresses the recoil spring.

Once fully to the rear, the compressed recoil spring pushes the slide forward, stripping the next cartridge from the magazine into the chamber. If the magazine is empty, the magazine follower lifts the slide release into position where it can stop the forward progress of the slide and holds the slide open. If a cartridge is present in the magazine, the slide will push the cartridge from the magazine and into the chamber.

WARNING: Do not rely on the slide position to determine if the magazine is empty. Always check visually and physically to ensure the pistol is not loaded.

During the last 3mm of forward movement, the slide forces the angled surfaces of the barrel locking block against opposing angled surfaces on the recoil spring guide rod. This action pivots the locking block on the barrel up into engagement with the ejection port on the slide. The breech is now locked closed and the next shot can be fired.

OPERATING CONTROLS & COMPONENTS

WARNING: The P2000 Series LEM incorporates a double-action only mode of operation. Anytime the trigger is pulled with a cartridge in the chamber, the pistol will fire from the hammer-down position.

In the double-action only mode, the hammer always returns to the uncocked (forward) position after each shot. All shots are fired in the double-action only mode.

Decocking Button - Double action/single action variants of the P2000 Series use a serrated decocking button (lever) located on the rear, left side of the frame to uncocked a cocked pistol. Depressing the decocking button (usually using the thumb) safely drops the cocked hammer rendering the pistol safe and uncocked.

Magazine - The P2000 model uses the same magazines as the popular USP Compact. P2000 Series magazines are constructed of metal with polymer floorplates, followers and locking plate pieces. Cartridges are positioned within the magazine in a staggered arrangement but are fed into the pistol from a single row under the feed lips. The cartridges are visible through the numbered viewing holes located in the back of the magazine. For maintenance and cleaning, all P2000 Series magazines can be disassembled.

No Magazine Disconnect Feature - For maximum functionality, most P2000 Series models are not equipped with a magazine disconnect feature and can be fired with the magazine removed from the pistol. The ability to fire a semiautomatic pistol while in the process of loading or unloading is considered critical in a military, law enforcement or personal defense encounter. A magazine disconnect is only available as an optional feature on some new P2000 Series pistols (not the P2000SK) but can be retrofitted to some existing pistols. Please contact HK Customer Service for more information (tel. 706-568-1906).

NOTE: To verify the presence or absence of the magazine disconnect feature, CLEAR THE P2000 Series (inside cover & page 12), ensuring the chamber is empty, the pistol is unloaded, and pointed in a safe direction. With the magazine removed, press the trigger. If compressing the trigger activates the hammer and the pistol “dry fires”, no magazine disconnect is installed. If compressing the trigger fails to activate the hammer, a magazine disconnect is present.

WARNING: P2000 Series pistols, except special models with a magazine disconnect feature installed, will fire if the magazine is removed, a cartridge is in the chamber, and the trigger is pressed.

Ambidextrous Slide Release - A slide release lever is located on both the left and right side of the frame directly above the trigger. These levers are used to lock the slide open, to release the slide, and to disassemble the pistol. As a slide stop, it is lifted upward by the magazine follower or the operator's finger as the slide travels rearward during recoil or manual manipulation. The slide release engages in the recess located on the left side of the slide at its midpoint. The slide release is spring actuated and is held down out of engagement with the slide until required. The slide release will automatically hold the slide open when the last shot is fired. As a disassembly lever, the left side slide release is removed from the left side of the frame when the slide is held partially rearward. During disassembly, the slide release on the right side of the pistol remains attached to the frame until it is rotated upward approximately 45° and lifted off the frame.

NOTE: The right-side lever on all P2000 models must be rotated 45° to be removed or frame damage will result.

Magazine Release Lever - This ambidextrous, spring actuated lever holds the magazine in place within the grip by engaging in the notch found on the front of the magazine housing. Depressing this lever downward with the firing index finger or thumb will allow the magazine, regardless of the number of cartridges inside, to drop free of the frame. The magazine release lever is shielded from accidental actuation by the design of the polymer frame and flared trigger guard surrounding it.

Frame - All sides of the polymer frame are textured to ensure a firm grip, even with wet hands or under conditions of rapid fire. The trigger guard is tapered with the front surface grooved to provide a firm grip when using two hands or gloves to fire the pistol. The frame is a one-piece molded component with metal inserts (locking insert and guiding part) cast into the frame during production. The slide rides on these metal inserts during operation. The front of the frame exterior contains mounting grooves for the attachment of accessories. The bottom rear of the frame has finger recesses located to the left and right of the magazine well for manual extraction of the magazine, if necessary. The serial number of the pistol is engraved in the metal insert incorporated into the front of the frame, in front of the trigger guard, on the left side of the slide, and on the barrel locking block.

NOTE: Some evidence of wear in areas where the polymer frame and steel slide interface is normal.

SIGHTS AND SIGHT ADJUSTMENT

The P2000 Series uses the proven 3-dot sighting arrangement. By aligning all three dots horizontally on the target, with the front sight dot centered between the rear sight dots, the operator can quickly and easily engage the target with a high degree of accuracy. The rear sight can be adjusted for windage by drifting the sight to the left or to the right, depending on the desired shot placement. Bullet impact on target will move in the same direction that the rear sight is moved. Be careful not to damage the slide or slide finish when adjusting the rear sight. Adjustments for elevation are accomplished by exchanging the front sight with a higher or lower sight. The height of the front sight is indicated on the bottom of the sight blade. The front sight must be removed by using a drift punch or an HK-approved sight pusher (contact HK Customer Service Staff for more information).

To raise the bullet impact on target, a shorter front sight is installed. To lower the bullet impact on target, a taller front sight is installed. Installing the next higher or lower front sight will change the point-of-impact 2 inches at 25 meters, depending on the ammunition used. P2000 Series pistols are function fired and zeroed at the factory at 25 meters, point-of-aim, point-of-impact. Your actual zero may vary depending on the ammunition used and/or your style of shooting.

SECTION 4 AMMUNITION

WARNING: HK specifically disclaims any responsibilities for any damage or injury that should occur because of, or as a result of, the use of faulty, remanufactured, or reloaded (hand loaded) ammunition, or of cartridges other than those for which the pistol was originally chambered for.

The HK P2000 Series pistols are designed to fire quality, factory-loaded ammunition, loaded to NATO or SAAMI specifications for use specifically in handguns.

The following guidelines should be considered when selecting the correct ammunition for your pistol:

1. Be sure the ammunition you have chosen is compatible with your pistol—proper caliber, cartridge, bullet weight, etc. Caliber markings on P2000 Series pistols appear on the left side of the slide and on the barrel locking block, visible through the ejection port on the right side of the slide.
2. Prior to loading the magazine and chamber, carefully inspect all cartridges for the following abnormalities:
 - Cracked, split, dirty or corroded cases
 - Improperly seated projectiles and/or primers
 - Damaged projectiles.
3. Do not attempt to fire a cartridge in which the projectile has been forced back into the case. Upon firing, this condition may result in increased chamber pressure above safe limits.
4. Do not fire ammunition through a pistol that:
 - Is foreign and/or outdated military surplus
 - Is assembled with corrosive primer and/or propellant
 - Is exposed to oil, grease, water or direct sunlight. If possible, remove contaminants before use and cool down ammunition exposed to direct sunlight or heat. (Exposure to sources of heat could raise the chamber pressure of the cartridge above safe limits.)
 - Is loaded specifically for use in submachine guns.

CAUTION: HK firearms are designed to function with quality, manufactured brass-cased ammunition. Use of steel or aluminum-cased cartridges is not recommended and could adversely affect safe and reliable functioning. Use of cast-lead bullets is also not recommended.

NOTE: HK handguns are safe for use with new, high-quality U.S. factory ammunition manufactured to SAAMI specifications. For further information go to www.saami.org or contact the manufacture of your ammunition directly.

WARNING: The use of incorrect ammunition in the pistol could result in damage to the pistol and/or injury to the operator or bystanders. Be careful not to inadvertently mix 9 mm and .40 caliber ammunition. 9 mm ammunition will slide past the chamber and into the barrel in a .40 caliber pistol causing a barrel obstruction resulting in damage to the pistol and/or personal injury.

FILLING AND EMPTYING THE MAGAZINE

NOTE: Do not attempt to load more than the prescribed number of cartridges into the magazine. Do not alter the shape of the magazine housing, follower or spring. To do so may cause stoppages or the magazine may not seat properly in the pistol.

Filling the Magazine

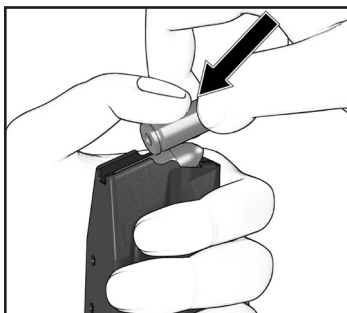

Figure 5

1. Hold the magazine in the non-firing hand with the back side of the magazine resting against the palm.
2. Using the firing hand, hold a cartridge between the index finger and thumb with the projectile facing the palm.
3. Press the rim of the cartridge down against the forward edge of the magazine follower or on the top cartridge already in the magazine.
4. Slide the cartridge back into the magazine under the feed lips.
5. Repeat steps 1-4 until the magazine is full. The viewing holes in the back of the magazine allow the operator to confirm the number of cartridges present within the magazine.

Emptying the Magazine - Exert pressure with a finger on the base of the cartridge and push each cartridge forward out of the magazine one at a time until the magazine is empty.

LOADING

WARNING: Forcefully inserting a loaded magazine into many pistols may cause the pistol's slide to close, chambering a cartridge and making the pistol ready to fire. When inserting a magazine, always be sure the P2000 Series is pointed in a safe direction with your fingers off the trigger and outside the trigger guard. Failure to do so could cause you to unintentionally fire the pistol, resulting in serious injury or death.

Administrative Loading - Used to initially load the pistol before it is to be fired.

Slide rearward or forward, chamber empty.

1. Make sure fingers are outside of the trigger guard and the pistol is pointed in a safe direction at all times!
2. Insert magazine - Insert the magazine firmly into the frame. Tug on the magazine to insure that it is fully seated and engaged.
3. Chamber a cartridge - Chamber a cartridge by depressing the slide release or by pulling the slide fully to the rear and releasing it. Do not ride the slide forward!

4. Top off - Remove the magazine and top it off by inserting one additional cartridge.
5. Replace Magazine - After topping off the magazine, replace it in the pistol and ensure that it is properly seated and engaged.

FIRING

WARNING

1. Be sure of your target and what's behind it! A bullet from a pistol travels as far as a mile. It can easily penetrate wood or plasterboard walls or even a car door.
 2. Be sure that your hands and all parts of your body are kept away from the muzzle of your pistol at all times!
 3. Always wear eye and ear protection when firing the pistol.
-

Double-action only mode - (Hammer uncocked)

1. Aim - Aim at the target.
2. Fire - Fire the pistol by pressing the trigger straight to the rear with gradually increasing pressure.

NOTE: The P2000/P2000SK (LEM V2) fires in the double-action only mode and its hammer will automatically return to the uncocked position each time the slide returns to its forward position and the trigger is released.

DA/SA action mode - (Hammer cocked)

1. Aim - Aim at the target
2. Fire - Fire the pistol by pressing the trigger straight to the rear with gradually increasing pressure.

NOTE: In the DA/SA mode, the P2000 Series (V3) pistols fire in double-action mode for the first round. After the first round, the hammer will automatically return to the cocked position each time the slide returns to its forward position and the trigger is released.

UNLOADING - To unload the pistol, follow the "Clearing" procedure.

Clearing the Pistol - The P2000 Series pistol is not considered "clear" or safe unless:

1. The magazine is removed from the pistol.
2. The slide is locked to the rear.
3. The chamber is free of brass or ammunition.

To Clear the HK P2000 Series:

1. Make sure fingers are outside of the trigger guard and the pistol is pointed in a safe direction at all times!
2. Remove magazine - Depress the magazine release lever and remove the magazine from the pistol.
3. Open and lock slide - While pointing the pistol in a safe direction, lock the slide open by pulling the slide rearward as you press the slide release upward. Watch for a cartridge or empty case to be ejected from the pistol.
4. Inspect chamber - Inspect chamber for the presence of a cartridge or empty case by:
 - Visually viewing chamber through open ejection port.
 - Physically inserting finger into chamber through ejection port to check for the presence of a cartridge or empty case.

Remove any cartridges or empty cases from the chamber or from within the pistol.

The HK P2000 Series pistol is now considered "Clear".

If the pistol fails to fire, clear and disassemble it and check for:

1. Obstructions in the chamber, bore or frame. Remove obstructions.
2. Bad ammunition. Try new ammunition.
3. Damaged magazine. Replace magazine.

4. Fouling or lack of lubrication. Clean and lubricate the pistol in accordance to the instructions contained within this manual.
5. Evidence of severely worn or broken parts. Contact HK or your unit armorer.

If your pistol still fails to operate correctly, contact your unit armorer, authorized HK dealer, or HK's Customer Service Department for guidance.

WARNING: If a cartridge is assembled without powder (a fault of the manufacturing process), the primer alone has enough power to propel the bullet into the bore. A bullet lodged in the bore may cause damage to the barrel and/or pistol if another cartridge is fired and could cause personal injury or even death. This event is commonly called a "squib load" or "pop and no kick," and is characterized by a reduced report and little or no movement of the slide. An alert operator could notice the occurrence of this event in time to avoid firing the next cartridge.

SELECTION AND USE OF A HOLSTER

Selection - When selecting a carrying holster for the HK P2000 Series pistols, it is important to consider the following points:

1. The holster must not make contact with or actuate any of the operating controls. This includes the hammer, slide release, magazine release lever, and most importantly the trigger. The design of the holster must also not actuate these controls when the pistol is carried in, drawn from or returned to the holster.
2. The holster should not cause the slide to move (unlock) when the pistol is returned to the holster.
3. Accommodations must be provided in the holster for any accessories that might be present on the pistol.
4. Choose a holster designed specifically for a P2000 Series pistol. A list of manufacturers that make holsters for a variety of HK pistols is available at the Heckler & Koch website or by contacting HK Customer Service.

Returning the pistol to the holster - The P2000 Series pistol must be made "Safe" (or cleared) prior to returning it to the holster. The pistol is considered safe to return it to the holster when:

1. All fingers are off of the trigger and out of the trigger guard.
2. The pistol is "clear."
3. In DA/SA mode, pistol is decocked and the safety is on (if applicable)

WARNING: The pistol must never be returned to the holster unless the above procedures have been followed or injury or death could occur.

STORAGE AND TRANSPORT

1. Store or transport the pistol and its components clean and lubricated.
2. Store and transport the pistol without cartridges in the chamber, magazine or in the storage container.
3. Store and transport the pistol with the slide forward and the hammer down (uncocked).
4. Clean and lubricate the pistol and its components at least every twelve (12) months during storage.
5. Store the pistol and its components in a clean, dry, dust-free environment with regulated temperature controls.
6. Store the pistol and ammunition separately under lock and key.

Long-Term Pistol Storage - Anytime the slide is moved fully rearward on any Variant 1 or 2 (LEM enhanced DAO) P2000 Series, the hammer spring is compressed and held in that position until the cocking piece is released by pulling the trigger on the pistol. Therefore, for long-term storage (more than 1 year), it is suggested that the pistol first be CLEARED (refer to page 12) and made safe, then pointed in a safe direction and dry fired to release pressure on the hammer spring to maintain its life span. Store magazines empty to maintain maximum spring life span.

NOTE: For optimal long-term storage, clear the V2 P2000 Series and release pressure on the cocking piece and hammer spring by dry firing the pistol one time.

INTERCHANGEABLE BACKSTRAPS

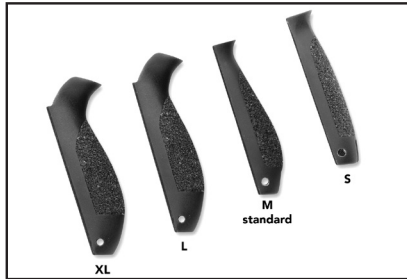

Figure 6
P2000 Extra Large, Large, Medium (standard), & Small Backstraps
(P2000SK include a Medium and Large Backstrap)

Backstrap removal for all P2000 Series pistols - Ensure the pistol is CLEAR and decocked (see page 3) and the magazine is removed. Dry firing the pistol will relieve any tension on the hammer spring prior to removal of the backstrap. With an appropriate metal punch, carefully tap out the lanyard loop roll pin (Figure 7).

Extract the pin once it is protruding from the frame. When the pin is removed, the backstrap can be slid downward off the frame (Figure 8). Take care that the hammer strut and hammer spring do not fall out of the frame and become lost or damaged.



Figure 7



Figure 8

Backstrap installation for all P2000 Series pistols - Ensure the hammer strut and hammer spring are properly positioned on the back of the frame (Figure 9). Place the replacement backstrap on the back of the frame, approximately 1 inch (2.54cm) lower than its assembled position (Figure 10), and push the backstrap up onto the grip rails.



Figure 9



Figure 10

Continue pushing the backstrap upward on the frame. As the backstrap slides upward onto the grip rails, the hammer spring will compress slightly creating resistance. Continue to slide the grip panel upward until it fits flush and there is no gap between the top of the backstrap and frame.

At this point, the pin holes on the backstrap and the frame will line up. Carefully reinsert the pin and push it through the panel and frame using finger pressure (Figure 11).

With the pin properly aligned in the backstrap and the frame, carefully tap the pin until it is fully seated and centered in the frame (Figure 12).



Figure 11

Hold the Backstrap in place while
Inserting the pin.



Figure 12

Carefully tap the pin all the way back in.

CAUTION: Be careful not to damage the P2000 Series when removing and installing backstraps.

Clear the pistol by following the directions on the inside cover

Disassembly (Field Stripping) of P2000/P2000 SK pistol

1. Make sure the pistol is CLEAR.
2. Depress the slide release and allow the slide to move forward.
3. Using the firing hand, retract and hold the slide to the rear so that the axle of the slide release is visible through the recess in the left side of the slide (see Figure 13).
4. With the non-firing hand, completely remove the left slide release from the left side of the frame by pressing on the axle of the slide release from the right side of the frame. The right slide release will remain attached to the frame.



Figure 13

5. Remove the slide with barrel and recoil spring assembly by sliding it forward off of the frame (see Figure 14 below).



Figure 14

6. Carefully remove the recoil spring assembly from the barrel and slide by lifting up on the rear of the recoil spring guide rod. The entire assembly can now be lifted out of the slide (see Figure 15). P2000 and P2000 SK pistols use a "captive" recoil spring assembly. Disassembly of the recoil spring is not recommended.
7. Lift the rear of the barrel by the locking block and withdraw it from the slide.
8. Remove the right slide release by rotating it upward approximately 45° and lifting it out of the frame.

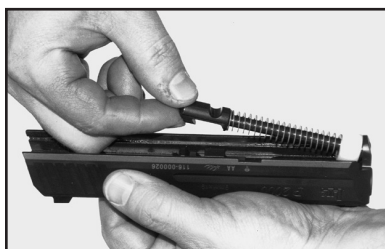

Figure 15

NOTE: Disassembly of the pistol is now complete. Only an HK certified armorer should disassemble the pistol further.

P2000 & P2000 SK Pistol Assembly

1. Install the right slide release into the recess located on the right side of the frame and rotate it downward until it is parallel to the top of the frame. Ensure that the tab on the lever is engaged in the recess cutout in the frame and that the lever is then pushed into the frame and rotated downward approximately 45°.
2. Position the barrel in the slide so that:
 - The muzzle of the barrel fits in the hole in the front of the slide.
 - The locking block portion of the barrel fits within the ejection port and the angled locking surfaces of the locking block are visible along the bottom of the slide.
3. Install the recoil spring assembly into the slide so the front of the recoil spring guide rod engages in the small hole provided in the front of the slide.
4. Align the opposing angled locking surfaces on the rear end of the recoil spring guide rod with those located on the bottom of the barrel locking block (see Figures 16 & 17).
5. Push the rear of the recoil spring assembly forward enough so that the recoil spring retainer can be engaged on the shelf provided on the front of the barrel locking block (see Figure 16, 17, & 18).

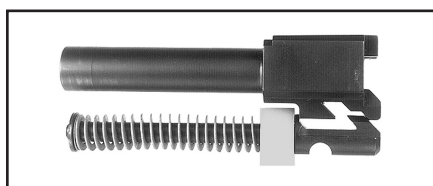

Figure 16 (relationship of recoil spring assembly to barrel locking block inside of slide)

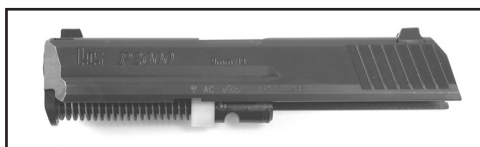

Figure 17 (recoil spring assembly and barrel properly positioned in the slide)

6. Hold the slide in the non-firing hand with the thumb holding the rear end of the recoil spring assembly in place on the slide.



Figure 18

7. Check the position of the sear axle on the frame. Ensure that it does not protrude from either side of the frame.
8. Hold the frame in the firing hand. Position the rear of the slide above the front edge of the frame.
9. Slowly draw the slide back onto the frame so that the metal inserts in the frame fit into the grooves on the inside of the slide (see Figure 19).



Figure 19

10. Retract the slide to the point where the recess in the left side of the slide is positioned over the hole where the axle of the slide release will go and hold it there.
11. Insert the slide release from left to right into the frame until it is flush with the side of the frame.

NOTE: Assembly of the pistol is now complete. Clear the pistol and check it for correct assembly and operation. Be sure the slide moves freely on the frame and with the pistol cleared and pointed in a safe direction, ensure all controls operate correctly. As applicable, check double-action only mode, slide release, and the magazine release.

MAGAZINE DISASSEMBLY

NOTE: European P2000 magazines will not fit the P2000 model sold in the USA.



Figure 20 10-round and high-capacity magazines



Figure 21

CAUTION: Beware of the spring tension exerted by the magazine spring while removing and installing the magazine floorplate. Keep the base of the magazine pointed in a safe direction (away from the face and eyes) at all times during disassembly and reassembly and wear eye protection.

Disassembly of high-capacity magazines

1. Using a blunt, pointed instrument, depress the locking detent located in the floorplate and hold it there (see Figure 21).
2. Place a portion of either hand over the base of the magazine to control the release of the magazine spring and locking plate.
3. Slowly slide the floorplate forward off of the magazine housing.
4. Gradually allow the locking plate and magazine spring to expand out of the magazine housing (see Figure 22).
5. Remove the locking plate, magazine spring and magazine follower from the magazine housing.

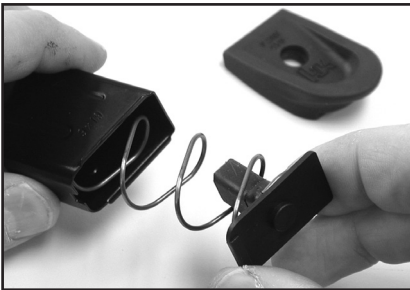

Figure 22
Locking plate and spring

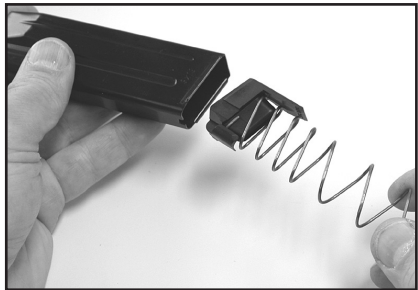

Figure 23
Magazine spring and follower

Disassembly of 10-round magazines:

1. Using a blunt, pointed instrument, depress the locking insert detent located in the floorplate and hold it there (see Figure 21).
2. Place a portion of either hand over the base of the magazine to control the release of the magazine spring and locking insert.
3. With the locking insert detent still depressed, squeeze the floorplate locking tabs located on the right and left sides of the magazine.

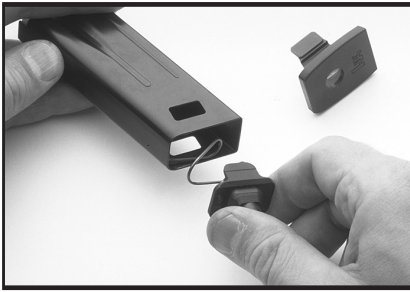

Figure 24



Figure 25
P2000/USP Compact
10-round magazine disassembled

4. Gradually allow the locking insert and magazine spring to expand out of the magazine housing (see Figure 24).
5. Remove the locking insert, magazine spring and magazine follower from the magazine housing.

MAGAZINE ASSEMBLY



Figure 26

1. Place the magazine follower onto the magazine spring with the end of the spring positioned on the left of the follower.
2. Insert the follower and magazine spring into the magazine housing as depicted in Figure 26.
3. Place the locking plate or locking insert onto the protruding end of the magazine spring so that the rounded corners face toward the front of the magazine.
4. Push the locking plate down into the magazine housing against the pressure of the magazine spring and hold it there.
5. On 10-round magazines, push the floorplate up onto the base of the magazine housing until the locking tabs engage in the sides of the housing.
6. Check to see if the locking tabs on the floorplate are securely locked into the housing and the locking detent on the locking plate fits within the hole in the floorplate.

On all magazines, check the magazine for proper assembly by insuring that the follower slides up and down freely within the magazine housing and with spring tension. Also check that the magazine follower rises within the magazine housing to be nearly flush against the bottom of the magazine feed lips.

NOTE: The service life and performance of your HK P2000 Series pistol is dependent upon the correct handling and proper care by the operator.

Materials Required - At a minimum, we suggest the following materials to properly clean the P2000 Series:

- Cleaning rod with handle and patch holder
- Nylon toothbrush
- Bronze bristle bore brush (in the appropriate caliber)
- Cleaning patches (in the appropriate caliber)
- Lint-free wiping rag
- Cleaning solvent/lubricant
- Cotton swabs

CAUTION: Use safety goggles when using solvents and exercise care if using compressed air.

HK Handgun Cleaning Kits, #701956 (9mm & .357SIG), #701957 (.40 S&W) are available from HK for thorough cleaning of HK pistols and other firearms.

Cleaning Intervals - Normal and Major are the two types of operator cleaning for the P2000 Series pistol.

Normal Cleaning - Performed after each firing or every twelve (12) months.

Major Cleaning - Often referred to as "detailed cleaning." Performed after the firing of 500 cartridges or when the pistol is exposed to, or laden throughout, with sand, dust, water (especially salt water) or other visible contaminants or foreign matter.

Normal Cleaning

CAUTION: Do not use a stainless steel bore brush which can scratch the polygonal bore and reduce accuracy.

Slide -

- Gently scrub all internal surfaces of the slide using the nylon toothbrush moistened with solvent.
- Remove all loose fouling from all surfaces of the slide using a rag and cotton swabs.

Recoil spring assembly -

- Remove all visible fouling using solvent, a nylon toothbrush or a rag and cotton swabs.

Barrel (with locking block) -

- Moisten a bronze bore brush with solvent and scrub the bore from chamber to muzzle at least six (6) passes, back and forth.
- Remove the loose fouling from the bore using cleaning patches.
- Gently scrub the exterior of the barrel and locking block with the nylon toothbrush moistened with solvent.
- Remove all loose fouling from the exterior of the barrel using a rag and cotton swabs.

Frame -

- Gently scrub all internal surfaces where carbon fouling is present using the nylon toothbrush moistened with solvent. Concentrate on the area normally covered by the slide.
- Using a rag and cotton swabs, remove all loose fouling from all areas of the frame.

Magazine -

- Gently scrub the top of the magazine, concentrating on the follower and feed lips, using the nylon toothbrush moistened with solvent.
- Using a rag and cotton swabs, remove all loose fouling from all surfaces of the magazine.

Major Cleaning - Major Cleaning is the same as normal cleaning except that:

- The magazine is disassembled for cleaning.
- All parts should be rinsed with or immersed in solvent and thoroughly scrubbed with a nylon brush. The parts can then be dried using compressed air or with a rag and cotton swabs.

NOTE: All parts of P2000 Series pistols can be immersed in any cleaning solvent that is safe to put your hands into, including ultrasonic cleaning solution. Use of ultrasonic cleaning machines can result in the unwanted removal of colored reference markings of the frame and extractor. Use of ultrasonic cleaning is normally not necessary or recommended when using standard ammunition in HK pistols with less than 10,000 rounds of service. All components should be thoroughly dried after being immersed in solvents of any kind before reassembly and all of the firearm's critical components should be lubricated in accordance with the applicable operator/maintenance instructions after being thoroughly dried. For special cleaning recommendations under extreme conditions, please contact HK Customer Service.

INSPECTION

During and after cleaning, visually inspect the pistol and its components for any irregularities that may cause problems or stoppages during operation. Generally, you should keep a watchful eye out for the discrepancies listed below.

Always clear the pistol before conducting your inspection!

Check for:

- Damaged or missing parts
- Improper assembly or function
- Absence of free movement, where applicable
- Absence of spring tension, where applicable
- Unaccustomed looseness
- Parts exhibiting signs of cracks, burrs, dents or obvious signs of damage or stress
- Presence of stops or tactile clicks, where applicable
- General overall cleanliness
- Presence of sufficient lubrication
- Presence of corrosion or degradation of surface finish.

CAUTION: HK pistol designs represent an optimization of a combination of safety, speed of deployment, accuracy, dependability, and durability. Do not attempt to make an HK pistol "better" by altering any of its components. Altering any part of the pistol or magazine may cause injury or death and will also void any HK warranty on the product.

LUBRICATION

Metal surfaces of the P2000 Series pistol are treated with HK's special corrosion and wear-resistant finish. This surface treatment does not completely reduce the friction between moving parts and it is recommended that a lubricant be applied to the pistol to ensure proper functioning. Any type of high-quality, medium-weight lubricant (oil) specifically designed for use on firearms will work well on the P2000 Series pistols. Do not use lubricants that boast of their ability to penetrate metal as these substances may deaden primers.

Where and How Much -

No Lube - Surface is dry and not slippery to the touch.

- All plastic and rubber components

Light Lube - A finger run across the surface yields little or no lube.

- Bore, chamber and exterior of barrel
- All metal parts
- All internal parts in slide and frame
- Magazine spring
- Recoil spring assembly
- Sights
- P2000 Series pistol metal magazine housing, where applicable

Medium Lube - A finger run across the surface yields some lube, but lube does not run down surface when it is held in a vertical position.

- Barrel locking block
- Slide rails and grooves
- All operating controls
- Locking insert and guiding part in frame
- Extractor

Heavy Lube - Lubrication runs down the surface when it is held in a vertical position.

No heavy lube is required on the HK P2000 Series pistols.

Re-apply lubricant periodically during firing as it burns off from the heat. Apply lubricant using a clean shaving brush, cotton swabs, patches or rag. A spray bottle of lubricant also works well when using compressed air to circulate the lubricant into all parts and to remove the excess from the pistol.

TROUBLESHOOTING PROBLEMS AND REPAIR

Common causes of problems that are often overlooked include:

- Fouled or improperly lubricated pistol
- Bad ammunition
- Damaged magazines
- Operator error

If your P2000 Series pistol still fails to function, please contact HK Customer Service at 706-568-1906 for the name and address of your nearest HK Authorized Repair Facility. Law enforcement users, contact your unit armorer or HK Customer Service.

NOTE: If after reviewing this manual you still have questions, please contact HK Customer Service at 706-568-1906 or by email: cs@heckler-koch-us.com.

WARRANTY REGISTRATION

New HK firearms are covered by Heckler & Koch, Inc.'s Limited Lifetime Warranty. Warranty registration is now online. To register your new HK firearm, go to: <https://hk-usa.com/warranty/registration/>

If you do not have access to the Internet, contact Heckler & Koch, Inc. to obtain a warranty registration form:

HK Customer Service
5675 Transport Boulevard
Columbus, GA 31907
Telephone: 706-701-5554.
Email: cs@heckler-koch-us.com

HECKLER & KOCH, INC. LIMITED LIFETIME WARRANTY

All new Heckler & Koch, Inc. firearms purchased after January 1, 1998, are warranted to the original retail purchaser only for the lifetime of the said original retail purchaser. In the event that this original retail purchaser, at the time of the original purchase, shall donate this firearm to another person, the donee name must be submitted during the online warranty registration. Heckler & Koch, Inc. does not guarantee or warrant that any, all, or some donations or gifts are valid and compliant with all applicable laws, regulations, and ordinances. Heckler & Koch, Inc. is not responsible or liable in any way for a donation or gift that does not comply with applicable laws, regulations, and ordinances. It is the responsibility of the original retail purchaser and the donee or recipient to ensure that any such transfer complies with all applicable laws, regulations, and ordinances. Upon completion of the online warranty registration indicating the name of the said donee, this warranty shall be extended to the lifetime of the said donee. This warranty applies only if the firearm was imported into the United States and distributed by Heckler & Koch, Inc. to an authorized dealer.

What Will We Do?

Heckler & Koch Inc. will, at its option, repair or replace without charge any HK firearm that fails due to a defect in materials or workmanship. Parts and labor are included. Repairs are warranted for the duration of the warranty. If Heckler & Koch, Inc. replaces a firearm under this warranty; you will receive a new warranty. Heckler & Koch, Inc. will return your firearm to you shipping pre-paid.

How to Obtain Service:

Contact Heckler & Koch, Inc. via phone at 706-701-5554 or email at cs@heckler-koch-us.com for a Return Authorization Number before sending your firearm freight prepaid to Heckler & Koch, Inc. at the address listed below. No C.O.D. shipments will be accepted.

Only the existing Heckler & Koch, Inc. Service Center or any other authorized Heckler & Koch, Inc. Service Center that may be established by Heckler & Koch, Inc. shall be authorized to make warranty repairs.

Return the complete, unloaded firearm with a detailed description of the problem using Heckler & Koch, Inc.'s Return Form.

DO NOT send any live ammunition with the firearm. If you must send ammunition to us for proof purposes, be sure that it is sent separately from the firearm.

We strongly recommend that you complete the online warranty registration at <https://hk-usa.com/warranty/registration/> to establish eligibility for warranty service. If you do not return an acknowledgment of online warranty registration to Heckler & Koch, Inc., you are required to provide adequate proof of the date that you purchased your new HK firearm at the time you send your firearm to Heckler & Koch, Inc. for warranty service.

In the event that this firearm was given as a gift at the time of original purchase, the online warranty registration with the name of the donee must be provided to Heckler & Koch Inc., in order for the warranty to become effective.

Note: Non-warranty servicing must follow the same shipping procedures as stated above. HK firearms with a valid Return Authorization Number should be shipped to the following address in accordance with these instructions:

HKI
Attn: Service Department/RA# _____
5675 Transport Blvd.
Columbus, GA 31907

Any information gathered in connection with a Heckler & Koch Inc. lifetime limited warranty shall be used for that purpose and may be used for other legitimate business purposes of Heckler & Koch Inc. For further information, please review Heckler & Koch, Inc.'s Privacy Policy, located at <https://hk-usa.com/cookie-policy-us/>

What Is Not Covered?

This warranty does not cover defects or damage caused by: (1) unreasonable use; (2) failure to provide proper care or maintenance; (3) failure to comply with instructions in the operator's manual including improper installation of original Heckler & Koch Inc. parts by the owner or his agent; (4) normal wear and tear for the degree of use; (5) rust or corrosion; (6) obstructions in the barrels; (7) excessive use; and/or (8) external and internal cosmetic finishes.

Heckler & Koch, Inc. reserves the right to determine what constitutes the unreasonable or excessive use of the firearm. All wooden parts and all accessories are excluded from warranty coverage.

This warranty does not cover any claims made by the second or subsequent owner of an HK firearm as stated above.

NOTICE Any unauthorized alteration or modification of the firearm or use of parts or components not originally made by Heckler & Koch, Inc. may void this warranty. Heckler & Koch, Inc. is not be responsible for any claims involving this firearm that result from the use of faulty, nonstandard, remanufactured, or reloaded ammunition or ammunition not manufactured to NATO, CIP, and/or SAMMI specifications.

Under no circumstances shall Heckler & Koch, Inc. be responsible or liable for incidental or consequential damages with respect to loss of use, loss of business or profits, other economic loss or injury to property, whether as a result of breach of express or implied warranty, negligence or otherwise. This Limited Lifetime Warranty applies only to retail purchases by individuals through an authorized Heckler & Koch, Inc. dealer.

Residents of CALIFORNIA, CONNECTICUT, DISTRICT OF COLUMBIA, HAWAII, MARYLAND, MASSACHUSETTS, MICHIGAN, NEW JERSEY, NEW YORK, AND U.S. TERRITORIES.

Any work involving replacement of the receiver of a firearm requires that the firearm be returned to a licensed firearms dealer. A current, signed copy of the dealer's FFL will be required. Please provide contact information for the chosen dealer, if applicable.

NOTICE Customers in restrictive capacity states: **DO NOT ship high capacity magazines to Heckler & Koch Inc. They cannot be returned.**

Exclusions

This lifetime warranty explicitly excludes firearms purchased by the United States military, government institutions or agencies of the United States or any of its constituent states and territories, law enforcement agencies of the United States or any of its constituent states and territories, and/or security organizations located within the United States or any of its constituent states and territories. Firearms purchased by these entities and organizations for duty issue to their personnel and/or employees are covered by a one-year limited warranty against material defects and workmanship or as agreed upon in a valid contract.

This lifetime warranty also excludes rimfire .22L R firearms, and all suppressors, which are covered by a one-year warranty.

Some states do not allow the exclusion or limitation of incidental or consequential damages, so the above limitations or exclusions may not apply to you. This warranty gives you specific legal rights, and you may also have other rights, which vary from state to state. This limited warranty is the only express warranty by Heckler & Koch Inc.

Heckler & Koch Inc. does not authorize any dealer or any other person to vary the terms of this warranty or make any other express warranties.

Heckler & Koch, Inc. Lifetime Barrel Guarantee

Heckler & Koch, Inc. guarantees the serviceability of the bore of the barrels of all MR A4 Series rifles and pistols for the lifetime of the original consumer purchaser for individual use. This guarantee is based on barrels meeting standards on accuracy, velocity, and useability across the entire life of the A4 system. If at any time an A4 barrel fails to meet these standards, Heckler & Koch, Inc. will replace the barrel.



Where to Get Further Help

If you have questions concerning this warranty, please contact Heckler & Koch, Inc.'s Customer Service Department at:

5675 Transport Blvd.

Columbus, GA 31907

Telephone: 706-701-5554

Email: cs@heckler-koch-us.com

LOCK-OUT DEVICE

P2000 Series pistols are equipped with a patented HK Lock-Out™ device. This component is part of the backstrap and when engaged, locks the handgun's action by blocking any movement of the trigger, the hammer and the slide. The handgun is locked and cannot fire until unlocked. The Lock-Out control plate is accessible through the pistol's magazine well (see Figure 27).

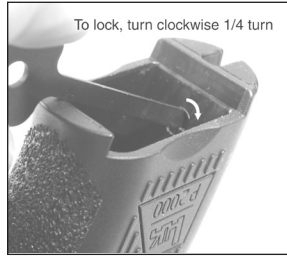

Figure 27

Turning the key clockwise 1/4 turn locks the action, turning it counter-clockwise unlocks the action.

Clear the pistol and dry fire it prior to activating the Lock-Out device. Use the two pronged key supplied with the pistol to lock or unlock the pistol as desired. When the holes on the Lock-Out device are horizontally positioned, the pistol is locked and cannot be fired (see Figure 28).

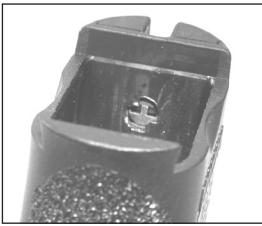

Figure 28
Locked position

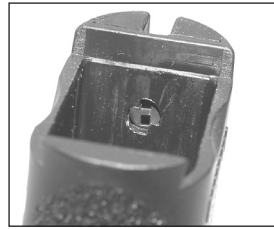

Figure 29
Unlocked/fire position

When the holes on the Lock-Out device are vertically positioned, the pistol is unlocked and can be fired (see Figure 29).

WARNING: The HK Lock-Out device is not a substitute for safe gun handling practices. Never point the muzzle of the pistol in an unsafe direction (at yourself or others). When the Lock-Out device is placed in the locked position, the slide is locked in the closed position and cannot be moved! Forcing the slide rearward while the gun is in this locked position will damage the pistol.

For more information contact HK Customer Service.

P2000 SERIES ACCESSORIES

The industry standard mounting rails found on the front portion of the frame of P2000 and P2000SK pistols allows a wide variety of lights, laser aimers, and accessories to be added by simply sliding them onto the open rail system.



Figure 30
Light mounted on P2000

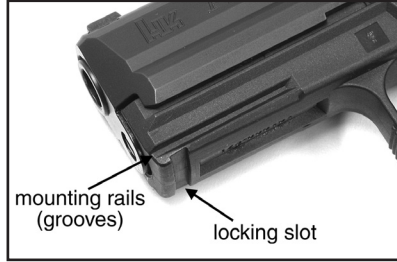

Figure 31
Detail of P2000 mounting rails

Follow the instructions of the manufacturer for installing, operating and removing accessories from the mounting rails. Always ensure a P2000 Series pistol is “clear” and unloaded before installing or removing accessories. Slide the accessory onto the rails until it locks into the locking slot located on the bottom of frame.



Figure 32

Slide the accessory onto the rails

XGRIP adaptors (Fig. 33 and 34) allow large capacity magazines that extend below the bottom of the magazine well to be used with the P2000SK. To use, simply slide the XGRIP over the magazine housing downward toward the floorplate. The XGRIP locks into place for a safe and secure assembly.



Figure 33
X-grip magazine adaptor for P2000SK (#702539)

The XGRIP adapts the HK P2000 high capacity magazine for use in the P2000SK incorporating the larger magazine into the P2000SK's grip and increasing the pistol's capacity to 13 rounds in 9 mm and 12 rounds in .40 caliber.

Users can carry the P2000SK with a standard magazine when concealment is important, then insert the full-size, high capacity magazine with the XGRIP installed when maximum firepower and capacity become critical.

The XGRIP has been designed to flow seamlessly into the design of the handgun itself, reinforcing the aesthetics and ergonomics of the pistol. No tools are required for installation. Increases capacity from 10 to 13 rounds for the 9mm, and from 9 to 12 rounds for the .40S&W and .357SIG.



Figure 34
XGRIP magazine adaptor shown in use on P2000SK

CAUTION: Improperly designed or installed accessories may result in damage to the mounting grooves and/or the pistol. Such damage is not covered under warranty. Be certain to use only HK approved accessories and follow installation and precautions carefully.

For a complete list of accessories that fit the P2000/P2000SK Series, please contact HK Customer Service.

This page intentionally blank.

SECTION 8 PARTS LIST P2000 (.40 S&W, 9 MM, .357 SIG)

Item	Description	Identification No.
1	Barrel .40 S&W	207164
	Barrel 9mm x 19	218550
	Barrel .357 SIG	202685
*	Recoil spring assembly complete .40 S&W (Items 2-5)	207188
*	Recoil spring assembly complete 9mm (Items 2-5)	209258
*	Recoil spring assembly complete .357 SIG (Items 2-5)	207188
2	Recoil spring guide rod	209307
3	Absorber bushing	215932
4	Recoil spring .40 S&W	215830
	Recoil spring 9mm	215852
	Recoil spring .357 SIG	215830
5	Recoil spring retainer	215831
*	Slide (complete) .40 S&W	207225
*	Slide (complete) 9mm	207312
*	Slide (complete) .357 SIG	202686
6	Slide .40 S&W	207165
	Slide 9mm	207280
	Slide .357 SIG	202687
7	Front sight (5.7)	209285
	Front sight (5.9)	209286
	Front sight (6.1)	209287
	Front sight (6.3) standard	209288
	Front sight (6.5)	209289
	Front sight (6.7)	209290
	Front sight (6.9)	209291
8	Rear sight	209284
9	Rubber plug, extractor	209294
10	Extractor spring	218315
11	Extractor	218314
12	Roll pin for extractor ISO 3x14	980838
13	Firing Pin Spring	215822
14	Firing pin	209295
15	Firing pin block spring	209962
16	Firing pin block	209313
17	Frame incomplete (.40, 9mm, .357)	207198
18	Trigger axle	214154
19	Trigger	209263
20	Trigger rebound spring	219441
21	Flat spring	219167
22	Trigger bar detent spring	209270
23	Trigger bar detent	209269
24	Trigger bar	207331
25	Magazine disconnect axle	207193
26	Magazine disconnect lever	207167
27	Magazine disconnect spring	207194
28	Hammer axle	209272
29	Sear	209320
*	Decocker for V3	209261
30	Catch	209273
31	Sear actuator latch	209274
32	Sear axle	214101
33	Disconnecter	209271
34	Hammer	209321
35	Cocking piece	209265
36	Cocking piece spring	209275

Item	Description	Identification No.
37	Hammer strut	209312
38	Hammer spring	214695
39	Backstrap with HK Lock-Out device, complete Size M	207192
*	Backstrap with HK Lock-Out device Size S	207281
*	Backstrap with HK Lock-Out device Size L	207283
*	Backstrap with HK Lock-Out device Size XL	207285
40	Roll pin for grip panel (ISO 3x20)	985014
41	Magazine release spring	215929
42	Magazine release	214818
43	Shaped spring	214171
44	Slide release (left side)	209267
45	Slide release (right side)	209268
46	Magazine housing (40 cal, 10-rd.)	215833
*	Magazine housing (9mm, 10-rd.)	215848
47	Follower (.40 caliber, 9mm)	215836
48	Magazine spring (.40, 9mm, 10-rd.)	214850
49	Locking plate (9mm 10-rd.)	215850
	Locking plate (.40 S&W)	215835
50	Extended floorplate (9mm, 10-rd.)	215983
*	Extended floorplate (.40 cal. 10-rd.)	215978
*	Flat Floorplate (9mm, 10-rd.)	215849
*	Flat Floorplate (.40 cal., 10-rd.)	215834
51	Magazine housing (9mm, 13-rd.)	215846
*	Magazine housing (.40 cal., 12-rd.)	215661
*	Magazine housing (.357, 13-rd.)	217816
52	Magazine spring (9mm 13-rd, 357 12-rd.)	214212
	Magazine spring (.40 12-rd.)	218587
53	Locking plate (9mm & 357 13-rd, .40 S&W 12-rd.)	215844
54	Extended floorplate (9mm, 13-rd.)	215980
	Extended floorplate (.40 cal. 12-rd.)	215663
	Extended floorplate (.357 13-rd.)	201184
*	Floor plate (9mm, 13-rd.)	215843
*	Flat Floor plate (.40 cal, 12-rd.)	215662
55	Magazine complete (13-rd, 9mm, with extended floorplate)	215981
	Magazine complete (12-rd., 40, with extended floorplate)	217439
	Magazine complete (13-rd, .357, with extended floorplate)*	217818
*	Magazine complete (10-rd, 40 cal.)	215832
*	Magazine complete (10-rd, 40 cal., with extended floorplate)*	215977
*	Magazine complete (12-rd, 40 cal.)	217438
*	Magazine complete (12-rd, 40 cal., with extended floorplate)*	217439
*	Magazine complete (10-rd, 9mm)	215847
*	Magazine complete (10-rd, 9mm, with extended floorplate)*	215982
*	Magazine complete (13-rd, 9mm)	215845

* Items not pictured in exploded view on
opposite page

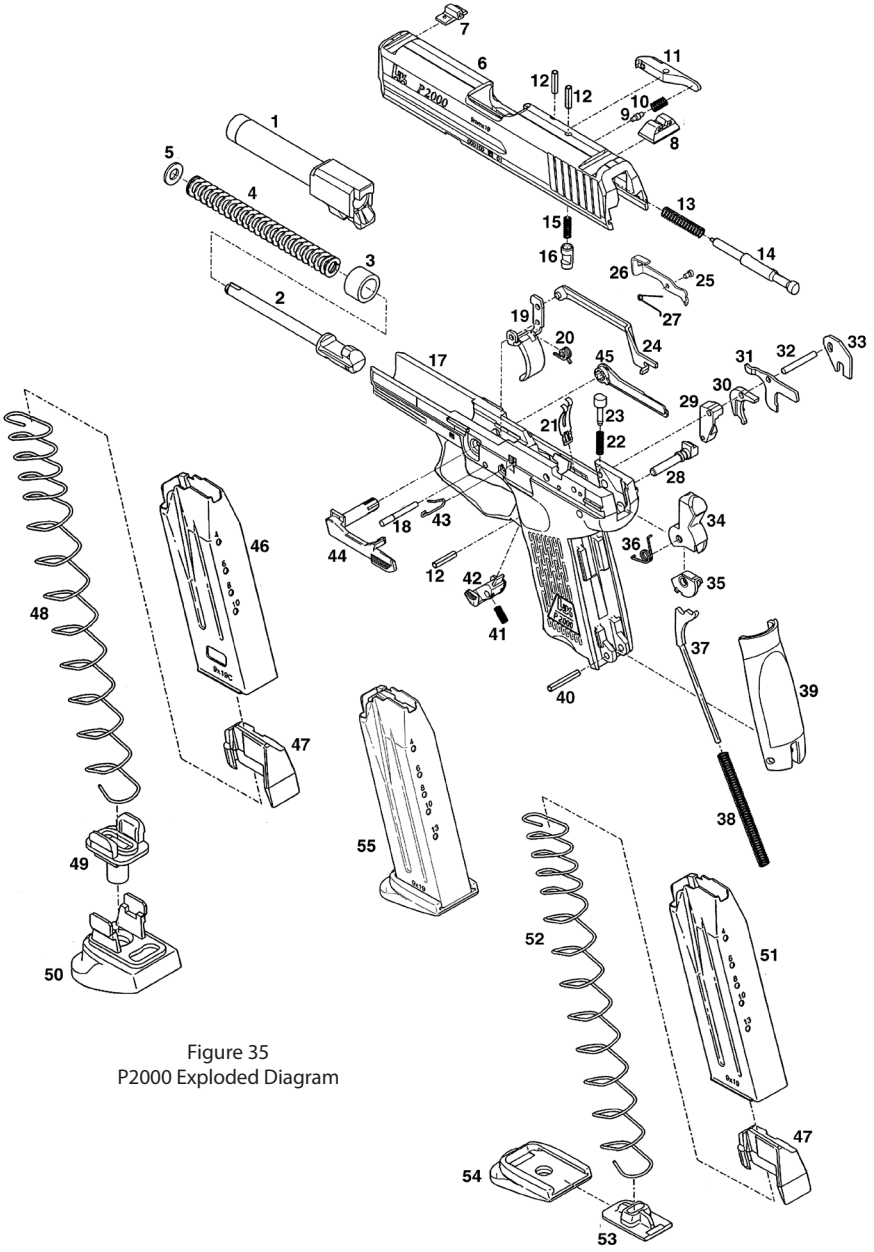

Figure 35
P2000 Exploded Diagram

PARTS LIST P2000SK SUBCOMPACT (9 MM, .40 S&W, .357 SIG)

Item	Description	Identification No.	Item	Description	Identification No.
1	Barrel (9mm x19)	207120	26	Sear axle	214101
	Barrel (.40 S&W)	207319	27	Disconnecter.....	209271
	Barrel (.357 SIG)	202688	28	Hammer	209321
2	Recoil spring assembly, complete	207119	29	Cocking piece	209265
*	Slide, complete (9mm x19).....	207221	30	Cocking piece spring	209275
	Slide, complete (.40 S&W).....	207321	31	Hammer strut	207121
	Slide, complete (.357 SIG).....	202689	32	Hammer spring	207122
3	Slide (9mm x19)	207124	33	Backstrap M (Medium).....	207222
	Slide (.40 S&W)	207322	*	Backstrap L (Large)	202604
	Slide (.357 SIG)	202690	34	Roll pin for backstrap	984023
4	Front sight (5.7)	209285	35	Magazine release spring	215929
	Front sight (5.9)	209286	36	Magazine release.....	214818
	Front sight (6.1)	209287	37	Shaped spring for slide release	214171
	Front sight (6.3)	209288	38	Slide release.....	209267
	Front sight (6.5)	209289	39	Slide release, right.....	209268
	Front sight (6.7)	209290	*	Magazine, complete (9mm)	207161
	Front sight (6.9)	209291	*	Magazine, complete (.40 S&W)	207323
5	Rear sight	209284	*	Magazine, complete (.357 SIG).....	contact HK
6	Rubber plug, extractor.....	209294	40	Magazine housing (9mm, .357 SIG)	207162
7	Extractor spring	218315		Magazine housing (.40 S&W)	207214
8	Extractor	218314	41	Follower (9mm, .40 S&W, .357 SIG)	215836
9	Roll pin for extractor	980838	42	Magazine spring (9mm, .40 S&W, .357 SIG)	207218
	Roll pin for firing pin.....	980838	43	Locking plate (9mm, .357 SIG)	202693
10	Firing pin spring.....	215822		Locking plate (.40 S&W)	215844
11	Firing pin.....	209295	44	Floorplate (9mm, .40 S&W, .357 SIG)	207216
12	Firing pin block spring.....	209962			
13	Firing pin block.....	209313			
*	Frame, complete	207318			
14	Frame.....	207200			
15	Trigger axle	214154			
16	Trigger	209263			
17	Trigger rebound spring	219441			
18	Flat spring	214167			
19	Trigger bar detent spring	209270			
20	Trigger bar detent.....	209269			
21	Trigger bar	207331			
22	Hammer axle.....	209272			
23	Sear.....	209320			
*	Decocker for V3	209261			
24	Catch	209273			
25	Sear actuator latch	209274			

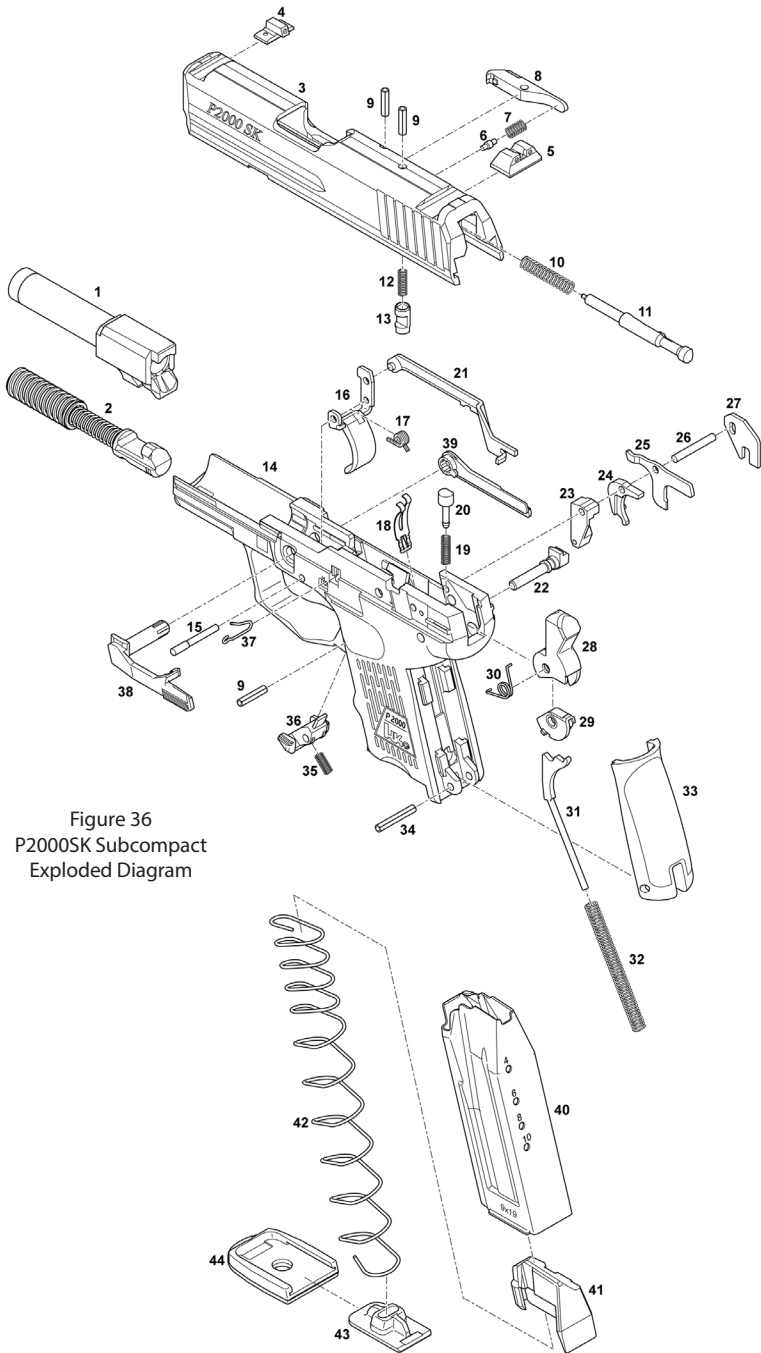

Figure 36
P2000SK Subcompact
Exploded Diagram



HECKLER & KOCH
5675 Transport Boulevard
Columbus, Georgia 31907
United States of America
Tel: (706) 568-1906
Fax: (706) 568-9151
USA Website: www.hk-usa.com