

MARK 23 OPERATOR'S MANUAL



CALIBER .45 ACP

SAFETY PRECAUTIONS

CAUTION: Read the safety rules before handling the pistol!

Read this operators manual before handling your firearm. The following safety rules are placed in this manual by HK as an important reminder that firearms safety is your responsibility. If handled improperly firearms can be dangerous and can potentially cause damage to property, serious injury, or death.

1. Never point a firearm at anyone, or in any direction other than a SAFE direction, i.e. downrange.
2. Treat all firearms as if they are always loaded.
3. Keep your finger off the trigger and outside of the trigger guard until your sights are aligned on the target.
4. Keep your finger off the trigger and outside of the trigger guard while loading or unloading the firearm.
5. Keep your finger off the trigger and outside of the trigger guard while pulling the firearm out of the holster or while returning it to the holster.
6. Be sure of your target and the back stop beyond.
7. Never give a firearm to or take a firearm from anyone unless the action is open and the magazine and/or chamber are free of any ammunition or brass.
8. Be sure that the ammunition you are using is factory loaded, is of the correct caliber for the firearm in which it is to be used, and that it is not damaged in any way.
9. Before firing, remove the magazine from the firearm, lock the slide open, make sure the chamber is clear of any ammunition or brass, and check the barrel of the unloaded firearm for any possible obstructions.
10. Before firing any firearm that is unfamiliar to you, make sure that you understand exactly how it functions. A lack of familiarity with the firearm can result in serious accidents. Attend a certified training course on any firearm which you intend to use or with which you are not sufficiently familiar.
11. Always wear hearing and eye protection when using your firearm.
12. Keep all body parts, particularly the hands and fingers, away from the muzzle to avoid injury or burns.
13. Be sure that parts of the hand do not touch or interfere with the slide. The slide moves backwards by recoil force during firing and may cause serious injury.
14. Firearms should be stored separately from ammunition and beyond the reach of children, and/or any untrained individuals.
15. Avoid the use of any alcoholic beverages or drugs before and during the use of any firearm.
16. Discharging firearms in poorly ventilated areas, cleaning firearms, or handling ammunition may result in exposure to lead, a substance known to be associated with birth defects, reproductive harm, and other serious injury. Have adequate ventilation at all times. Wash hands thoroughly after exposure.
17. To make the pistol safe, one must insure the chambered round is removed during the clearing procedure. Removal of the pistol's magazine does not remove the chambered round. This can only be done with the rearward movement of the slide after the magazine is removed.

STOP! KNOW HOW TO CLEAR THIS PISTOL BEFORE ATTEMPTING TO OPERATE.

CLEARING THE PISTOL

The pistol is not considered "clear" or safe unless:

1. The safety lever is set on "Safe"
2. The magazine is removed
3. The slide is locked to the rear
4. The chamber is free of brass or ammunition.

To Clear the pistol

1. Make sure fingers are outside of the trigger guard and the pistol is pointed in a safe direction at all times!
2. Decock Hammer or Engage Safety - Depress decocking lever or engage the safety lever.
3. Remove magazine - depress the magazine release lever and remove the magazine from the pistol.
4. Open and lock slide - while keeping the pistol pointed in a safe direction, lock the slide open by pulling the slide rearward as you press the slide release upward. Watch for a cartridge or empty case to be ejected from the pistol.
5. Inspect chamber - inspect chamber for the presence of a cartridge or empty case by:
 - Visually viewing chamber through the open ejection port and;
 - Physically inserting a finger into the chamber through the ejection port to check for the presence of a cartridge or empty case.
 - Remove any cartridges or empty cases from the chamber or from within the pistol.

The pistol is now considered "Clear."

WARNING: A firearm has the capability of taking your life or the life of someone else! Be extremely careful with your firearm. An accident can occur at anytime and is almost always the result of not following basic safety rules.

MARK 23 OPERATOR'S MANUAL



Covers all Mark 23 and MK23 Mod O (NSN 1005-01-426-8951) pistols.

Heckler & Koch
5675 Transport Boulevard
Columbus, Georgia 31907 USA
Tel: (706) 568-1906
Fax: (706) 568-9151
American Website: www.hk-usa.com
Global Website: www.heckler-koch.com

© Heckler & Koch USA (Heckler & Koch Inc. and Heckler & Koch Defense Inc.) Nov 2025
All rights reserved
Specifications and models subject to change without notice.

TABLE OF CONTENTS

Safety Rules	inside front cover
Section 1 Introduction	5
Section 2 Nomenclature	7
Specifications	7
Section 3 Principle of Operation	8
Major Assembly Groups	8
Section 4 Operating Instructions	9
General Description	9
Operation & Characteristics	9
Cycle of Operation	11
Safety Features	12
Section 5 Operation Under Normal Conditions	14
Clearing Procedures	14
Loading the Magazine	14
Unloading the Magazine	15
Readying the Pistol for Firing	16
Firing the Pistol	16
Section 6 Operation Under Unusual Conditions	17
Extreme Cold	17
Hot, Wet Climates	17
Hot, Dry Climates	17
Heavy Rain & Water Operations - All Climates	17
Section 7 Malfunctions & Stoppages	18
Remedial Action	18
Section 8 Selection and Use of a Holster	18
Selection.....	18
Returning the Pistol to the Holster.....	18
Section 9 Maintenance Instructions	19
Tools & Equipment	19
Operator Tools & Equipment Required	19
Preventative Maintenance Procedures	19
Disassembly (field stripping)	19
Reassembly (from field strip)	20
Safety/Function Check	23
Function Firing	24
Cleaning	24
Inspection	25
Lubrication	25
Section 10 Adjustment of Sights	27
Section 11 Troubleshooting Procedures	29
Section 12 Ammunition	31
Section 13 Parts Listing & Exploded Diagram	32
Section 14 HK Lockout Device	34

INTRODUCTION



Figure 1 MK23 (Mark 23) Cutaway

The Mark 23 .45 ACP pistol gives shooters match grade accuracy equal to that of the finest custom made handguns — yet it exceeds the most stringent operational requirements ever demanded of a combat handgun. The Mark 23 provides this accuracy without the need for hand-fitted parts, common in custom-built match pistols costing thousands of dollars more. Repair of the Mark 23 is reduced to a simple parts exchange.

The Mark 23 is a commercial model of the U.S. Government issue MK 23, MOD 0 pistol and is available in limited numbers. Designated the "Mark 23," it is almost identical to the MK 23, MOD 0 pistol used by the Special Operations Command, right down to its threaded barrel. The main differences are slide markings (Mark 23 as opposed to MK 23) and a barrel manufactured to SAAMI headspace specifications. One of the most thoroughly tested handguns in history, the MK 23/Mark 23 project originated in 1991 when HK was awarded a development contract for the Special Operations Forces Offensive Handgun Weapon System, consisting of a .45 caliber pistol, detachable sound and flash suppressor, and laser aiming module (LAM).

During testing, MK 23 pistols met the most stringent operational and accuracy requirements ever demanded of a combat handgun. MK 23 pistols achieved match grade accuracy of less than a 2.5-inch maximum extreme spread in 5-round shot groups at 25 meters with service ammunition. Endurance testing demonstrated a service life of over 30,000 rounds of +P ammunition with no parts breakage, with an additional 30,000 rounds certified on the slide and frame.

To meet the reliability requirement, the pistol had to demonstrate a minimum of 2,000 mean rounds between stoppages (MRBS) with both M1911 ball and +P ammunition. The minimum MRBS achieved in testing was 6,027 and the maximum was 15,122. Out of over 450 accuracy test firings from a precision firing fixture, MK 23 pistols far exceeded

the government requirement, averaging 1.44 inches with 65 groups of less than one inch. There were four groups of .5 inches with 5 rounds going through the same hole! This included firing with and without the sound/flash suppressor attached.

Three pistols were tested for accuracy after firing over 30,000 rounds, the specified service life of the pistol, and still met the new pistol accuracy requirement. An innovative design feature, a high temperature rubber O-ring on the barrel that seals the barrel in the slide until unlocking, led to this remarkable achievement. The O-ring lasts beyond 20,000 rounds and can be replaced by the operator without tools in seconds. To meet operational environmental requirements, the pistol was function tested at +140 and -250 F, immersed in salt water, exposed to surf, salt-fog, sand-dust, mud, unlubricated and a variety of other fouled environments. A special maritime surface coating protects the pistol from corrosion in all of these operational environments.

The barrel is threaded to accept accessories such as a flash and sound suppressor. The unique HK polygonal bore profile increases muzzle velocity and service life, reduces bore fouling and eases cleaning. The frame mounted Mark 23 decocking lever is separate from the ambidextrous safety lever. It allows the hammer to be lowered quietly and safely from the single-action position. When the hammer is down, the ambidextrous frame-mounted safety lever is locked in the fire position so that the pistol is always ready for double-action operation. When the hammer is "cocked and locked" in single-action mode with the safety lever on "safe," the decocker is blocked so that the pistol is always ready for single-action operation. Even with the safety lever engaged, the slide can still be manipulated to load and clear the pistol.

The extended slide release lever and the ambidextrous magazine release are easily operated without adjustment of the firing grip using the thumb or index finger of the firing hand. Other notable features include: accessory mounting grooves on the frame, a mechanical recoil reduction system that reduces recoil forces to the shooter and components of the pistol by as much as 30%, a polymer frame, a one-piece machined steel slide, and a 12-round magazine capacity. The weapon is aimed using either iron sights or an optional laser aiming component. The iron sights provide a 3-dot sight picture with white or optional self-luminous tritium dots. The MK 23 became the first .45 ACP caliber pistol to enter U.S. military service since the venerable Government Model 1911A1. On May 1, 1996, the first MK 23 pistols were delivered to the U.S. Special Operations Command for operational deployment.

SECTION 2 — NOMENCLATURE



Figure 2 Mark 23 (left)

MARK 23 PISTOL SPECIFICATIONS

Caliber	.45 ACP
Operating Principle	Short recoil, semiautomatic
Action Type	Modified Browning type, linkless
Sights	Fixed patridge style, adjustable for windage & elevation, standard 3-dot or optional tritium
Total Length	9.65 in. (245mm)
Barrel Length	5.87 in. (149mm)
Sight Radius	7.76 in. (197mm)
Twist Length	378 mm (14.88 in.)
Height without magazine	5.90 in. (150mm)
Width of Frame	1.58 in. (38.8mm)
Weight (with empty 12-round magazine)	2.66 lbs. (1.21 kg)
Weight of empty 12-round magazine	.81 lbs. (.366 kg)
Weight of empty 10-round magazine	.72 lbs. (.327 kg)
Slide Force (to retract slide)	8.5 kg (18.74 lbs.)
Trigger Pull Single-action	4.85 lbs. (2.20 kg)
Trigger Pull Double-action	12.13 lbs. (5.50 kg)
Magazine Capacity (does not include cartridge in chamber)	10 or 12 cartridges, .45 ACP
Safety Features	Double-action mode with hammer intercept notch, Firing pin block, Disconnecter

SECTION 3 — PRINCIPLE OF OPERATION

- A. The Mark 23 uses a modified linkless Browning-style short recoil system to lock and unlock the breech.
- B. Upon firing, the pressure developed by the propellant gas forces the slide and barrel assembly to the rear. After approximately 3mm, the locking block will stop the rearward movement of the barrel as the barrel is pivoted downward due to the engagement of the angled surfaces of the locking block with those located in the recoil spring guide rod. The locking block will disengage from the slide and the slide will continue rearward.

The extractor located in the slide will then extract the fired cartridge case. The ejector located in the frame on the left side of the magazine well will eject the fired case as the slide continues rearward and cocks the hammer and compresses the recoil spring. The slide moves forward feeding the next cartridge from the magazine into the chamber and locking to the barrel breech.

- C. The slide locks open after the last round has been fired and ejected.

WARNING: Do not rely on the slide lock to determine if the magazine is empty. Always check visually and physically to ensure the pistol is not loaded.

MAJOR ASSEMBLY GROUPS (SEE FIGURE 3)

- A. Slide - Houses the firing pin, firing pin block and extractor; cocks hammer during recoil.
- B. Captured Recoil/Buffer Spring Assembly (with guide rod) - Absorbs recoil and returns the slide and barrel to their forward positions; reduces impact of slide on receiver during recoil. The recoil spring is "captured" by a C-clip on the end of the guide rod.
- C. Threaded Barrel (with locking block) - Contains cartridge and propellant gases during firing. The locking block initiates locking and unlocking of the breech during movement of slide. The O-ring holds the barrel tight in the slide until unlocking.
- D. Frame - Serves as support to all major components; controls functioning of pistol. The slide release locks the slide with barrel and recoil/buffer spring assembly to the metal locking insert cast into the synthetic frame. A lanyard loop is in the bottom of the grip for attaching a lanyard. The trigger guard is flared on both sides to preclude accidental actuation of the magazine release during holstering.
- E. Magazine - Holds the cartridges in position for feeding and chambering.
- F. Slide Release - Holds slide to rear when engaged; releases slide when lever is depressed.

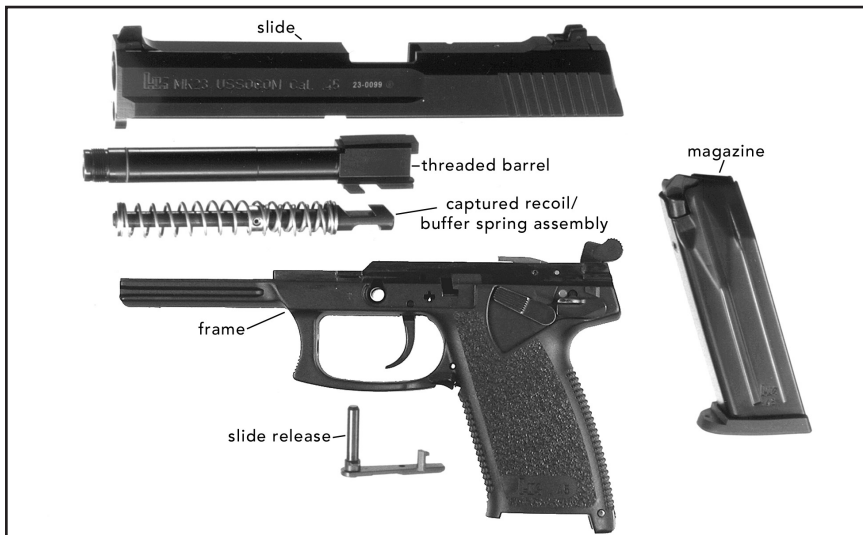

Figure 3 Major Assembly Groups

SECTION 4 — OPERATING INSTRUCTIONS

GENERAL DESCRIPTION

The Mark 23 is a semiautomatic, magazine fed, recoil operated, double/single-action pistol, chambered for the .45 ACP cartridge, up to and including the commercial +P cartridges.

WARNING: The Mark 23 incorporates single (SA) and double-action (DA) modes of operation. Anytime the trigger is pulled with the safety lever in the FIRE (downward) position and a round in the chamber, the pistol will fire from either the hammer down/lowered (DA) or cocked position (SA).

CAUTION: A pair of Universal Mounting Grooves located on the front of the Mark 23 frame allow for a variety of accessories to be used with the pistol. Improperly designed or installed accessories may result in damage to the Mark 23 mounting grooves and/or the Mark 23. Such damage is not covered under warranty. Use only HK authorized accessories and follow installation and precautions carefully.

NOTE: Accessories designed for the Universal Self-loading Pistol (USP) will not work on the Universal Mounting Grooves of the Mark 23.

OPERATION AND CHARACTERISTICS

- A. Double/Single Action** - For double-action (DA), pulling the trigger will cock the hammer and immediately release it, discharging a chambered round. To fire the first chambered round in single-action (SA), the hammer must be manually cocked before pulling the trigger. All shots after the first one will be fired single-action because the slide automatically recocks the hammer after each shot.
- B. Magazine** - The magazine is produced from sheet steel and has a total capacity of 12 rounds. The rounds are positioned within the magazine in a staggered

arrangement. Rounds are visible through the viewing holes located along the back side of the magazine housing. The viewing holes are marked with numerals denoting the number of rounds remaining within. The floorplate can be easily removed for disassembly and cleaning of the magazine components.

C. Loaded Chamber Indicator - The Mark 23 pistol does not have a loaded chamber indicator. The extractor does not act as a loaded chamber indicator.

D. Decocking Lever - The decocking lever allows the operator to quietly lower the cocked hammer without concern of an accidental discharge. When the hammer is cocked, it may be disengaged safely by moving the decocking lever fully into the decocking (down) position. The decocking lever cannot be depressed (and therefore does not allow the hammer to be disengaged) if the safety lever is engaged. The decocking lever always springs back into its disengaged (up) position due to the spring pressure exerted by the decocking spring.

E. Safety Lever - The safety lever is an ambidextrous "thumb" lever located on the rear of the frame. It is actuated by the firing thumb of the operator. The safety lever blocks the release of the cocked hammer when it is in the engaged (up) "safe" position (see Figure 4). The safety lever is depressed downward into the "fire" position (see Figure 5). The safety lever is not spring actuated and therefore must be moved manually from one position to the other by the operator.



Figure 4 "Safe" Position
(hammer cocked)



Figure 5 "Fire" Position
(hammer cocked)

NOTE: The safety lever cannot be placed in the "SAFE" (up position) if the hammer is uncocked.

WARNING: The pistol should always be carried with the safety lever engaged when carried in the single-action mode. The safety lever can be moved to the "fire" position (down) with a minimal amount of force (although there is a spring detent to provide some resistance to this movement). The safety lever could be inadvertently moved from "safe" to "fire" during careless handling or during removal of the pistol from the holster. Always check the position of the safety lever during handling.

F. Frame - The front and back straps of the fiberglass reinforced polymer frame are checkered to ensure a firm grip, even with wet hands or under conditions of rapid fire. The trigger guard is extended, recurved and grooved to provide a firm grip when using two hands or gloves. The bottom of the trigger guard is flared on both sides in front of the magazine release lever to shield the lever from accidental actuation.

A threaded insert is molded into the front face of the trigger guard and the frame is grooved forward of the trigger guard for attachment of an accessory such as a laser aiming device or an illuminator. The frame is a one-piece molded component with metal inserts (locking insert and guiding part) cast into the frame during production. The slide rides on these metal inserts during operation.

G. Slide Release Lever - This lever is used to lock the slide open and for disassembling the weapon. As a slide stop, it is depressed upward by the magazine follower or the operator's finger as the slide travels rearward during recoil or manual operation. The slide release lever engages the recess visible on the left side of the slide and is spring actuated. The slide release spring holds the slide release lever in a disengaged (down) position until required. As a disassembly lever, the slide release lever is removed from the left side of the frame when the slide is held rearward. The slide release lever can be actuated by the firing thumb of the right handed operator or the index finger of the left handed operator.

H. Magazine Release Lever - This ambidextrous spring actuated lever holds the magazine within the grip by engaging in the notch found in the upper third of the magazine housing. Depressing this lever with the firing hand index finger or thumb will allow the magazine to drop from the grip. The magazine release lever is shielded from accidental actuation by the flared trigger guard and the design of the synthetic frame surrounding the lever.

CYCLE OF OPERATION

Cycle of Operation begins with weapon loaded, hammer cocked and safety lever disengaged.

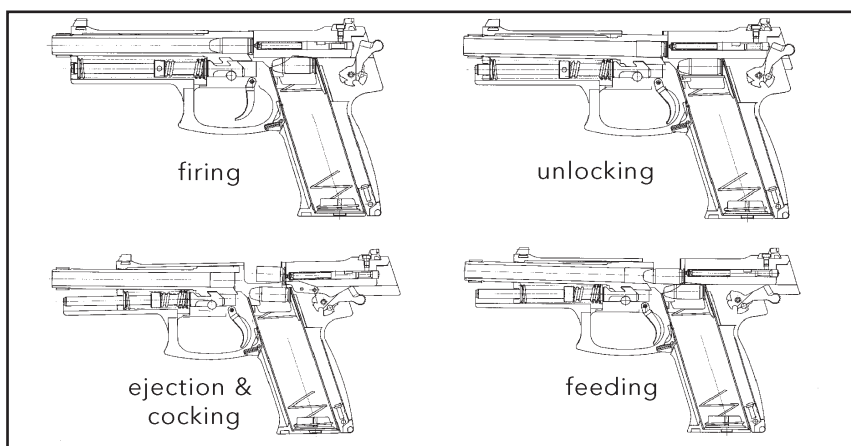

Figure 6 Cycle of Operation

A. Firing - Pulling the trigger rearward pulls the trigger bar forward. The trigger bar pivots the sear actuator upward which disengages the firing pin block. At the same moment, the sear is pivoted out of engagement from the lower of the two shelves located on the hammer. The compressed hammer spring drives the hammer forward into the rear end of the firing pin. The firing pin strikes the primer of the chambered round. The propellant is ignited by the primer and propellant gases are created inside the cartridge case. The propellant gases drive the projectile down the polygonal bore which spins the projectile in a clockwise direction as a means to stabilize the projectile's flight.

- B. Unlocking** - The gas pressure and energy produced by the propellant gases push rearward on the slide, which is locked to the barrel by the engagement of the barrel locking block within the ejection port milled into the slide. The opposing angled locking surfaces incorporated into the design of the barrel locking block and recoil spring guide rod cause the rear of the barrel to tilt downward as the slide moves rearward. By the time the slide and barrel have recoiled approximately 5mm, the projectile has left the barrel and the gas pressure within the chamber has dropped to a safe level. The barrel locking block then disengages from the slide. The slide is now free to recoil rearward independently of the barrel.
- C. Extraction** - The empty cartridge case is held firmly against the face of the slide by the claw of the extractor as the slide recoils rearward.
- D. Ejection** - The rim of the cartridge case strikes the stationary ejector. The empty case is ejected from the open ejection port.
- E. Cocking** - As the slide continues rearward the recoil impulse is dampened by the buffer spring. The recoil spring is compressed and the hammer recocked.
- F. Feeding** - The compressed recoil spring drives the slide forward. If the magazine is empty, the magazine follower will lift the slide release to a point where it will stop the forward progress of the slide. If the magazine is not empty, the face of the slide will make contact with the top round in the magazine. The round will be driven from the magazine toward the chamber. The tip of the projectile is guided into the chamber by the magazine lips until the round clears the magazine completely. At that moment the claw of the extractor snaps onto the rim of the cartridge case as it becomes parallel with the bore.
- G. Chambering** - The slide pushes the cartridge forward until the projectile enters the mouth of the forcing cone of the bore and the face of the slide contacts the rear of the barrel locking block.
- H. Locking** - The slide presses the barrel forward. As it does, the opposing angled surfaces of the barrel locking block and recoil spring guide rod pivot the rear end of the barrel up into engagement with the ejection port in the slide. The slide is now fully forward and the new round is ready to be fired.

SAFETY FEATURES

- A. Safety Lever** - This safety blocks the release of the cocked hammer in the SA mode. The safety lever is an external, manually operated, ambidextrous "thumb" lever located on the left and the right side of the frame further most back from the trigger. The safety lever must be manually actuated by the operator. The shaft of the safety lever moves the sear block into a position where it blocks the movement of the sear actuator. The sear actuator, in turn, does not allow the sear to pivot forward and thus the hammer cannot be released. Engaging the safety lever also interrupts the function of the decocking lever and blocks the hammer mechanically. The safety lever does not restrict the movement of the slide. The safety lever is held in either the fire or safe position by a spring detent. The safety lever cannot be placed in the safe (up) position when the hammer is down (uncocked).
- B. Double-Action Mode** - This safety keeps the hammer in an uncocked condition until the moment of firing. The double-action mode operates as a passive safety feature in the pistol, much as this mode of operation would in any DA revolver or pistol. The hammer is left uncocked until the decision to fire is made. At all times, the firing pin is locked by the firing pin block until the trigger is pulled.

Approximately 12.1 pounds of pressure on the trigger is required to cock and release the hammer in the DA mode of operation. The mode of operation also permits subsequent hammer strikes on the same chambered round by simply resqueezing the trigger.

- C. Firing Pin Block** - This safety prevents the firing pin from striking the primer when the weapon is dropped, the hammer is bumped, or when the slide slams forward. The firing pin block is located in the slide and blocks the forward movement of the firing pin. Only when the trigger is depressed can the sear actuator push the firing pin block upward against the downward pressure exerted by the firing pin block spring. Once the round has been fired and the slide begins to recoil, the firing pin block is pushed back down by the firing pin block spring and engages within the recess provided in the center portion of the firing pin.

- D. Disconnecter** - This safety prevents the release of the hammer unless the slide is fully forward and/or the trigger is reset (released) between rounds. This important safety prevents serious malfunctions from occurring, such as "slamfires" (rounds that fire during loading), automatic fire, or a round being fired out of the battery (with the breech unlocked). The disconnecter disconnects the engagement of the trigger bar and the sear actuator. The disconnecter is engaged (operating) after the slide has moved 2mm to the rear. The slide presses the leading edge of the disconnecter down and into engagement with the trigger bar. When the slide is fully forward, the leading edge of the disengaged disconnecter resides in a recess provided in the bottom of the slide.

SECTION 5 — OPERATION UNDER NORMAL CONDITIONS

WARNING: Always clear the pistol before handling it.

CLEARING PROCEDURES

The Mark 23 pistol is not considered "clear" or safe unless:

1. The safety lever is set on "Safe."
2. The magazine is removed.
3. The slide is locked to the rear.
4. The chamber is free of brass or ammunition.

NEVER ASSUME THE PISTOL IS CLEAR!

To Clear the Pistol:

1. **Make sure fingers are outside of the trigger guard and the pistol is pointed in a safe direction at all times!**
2. **Decock hammer or engage safety** - Depress decocking lever or engage the safety lever.
3. **Remove magazine** - Depress the magazine release lever and remove the magazine from the pistol.
4. **Open and lock slide** - while keeping the pistol pointed in a safe direction, lock the slide open by pulling the slide rearward as you press the slide release upward. Watch for a cartridge or empty case to be ejected from the pistol.
5. **Inspect chamber** - inspect chamber for the presence of a cartridge or empty case by:
 - Visually viewing chamber through the open ejection port and;
 - Physically inserting a finger into the chamber through the ejection port to check for the presence of a cartridge or empty case.
 - Remove any cartridges or empty cases from the chamber or from within the pistol.

LOADING THE MAGAZINE

1. Hold the magazine in one hand.
2. Hold a round between the index finger and thumb of the other hand with the projectile pointing towards the palm.
3. Press the rim of the round down against the front edge of the follower or the top round in the magazine and slide the round back under the magazine lips.
4. Repeat steps 1-3 until the magazine is full. The viewing holes in the back of the magazine allow the operator to confirm the number of rounds present within the magazine.

Loading and Unloading the Magazine - (see Figure 7)

The Mark 23 pistol is available with either 10 or 12-round magazines.

WARNING: Forcefully inserting a loaded magazine into the Mark 23 may cause the pistol's slide to close, chambering a cartridge and making the Mark 23 ready to fire. When inserting a magazine, always be certain that the pistol is pointed in a safe direction with your fingers off the trigger and outside the trigger guard. Failure to do so could cause you to unintentionally fire the pistol, resulting in serious injury or death.

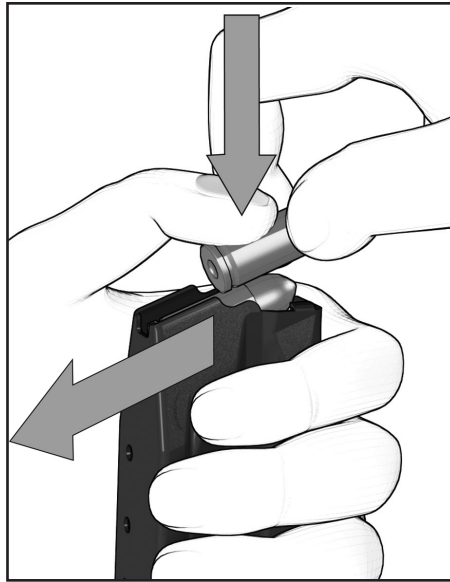

Figure 7

UNLOADING THE MAGAZINE

Exert pressure with the finger on the base of the cartridge case and push each round forward out of the magazine one round at a time until the magazine is empty.

Loading Procedure

Administrative Loading - Used to initially load the pistol before it is to be fired.

Method A (Slide rearward, chamber empty)

1. Make sure fingers are outside of trigger guard and pistol is pointed in a safe direction at all times!
2. Insert magazine firmly into the frame. Tug on magazine to insure that it is fully seated and engaged.
3. Depress the slide release lever to release the slide and to chamber the first round.
4. Engage safety lever or depress decocking lever.
5. Remove magazine and top off with one additional round.
6. Reinsert magazine insuring that it is fully seated.

Method B (Slide forward, chamber empty)

1. Make sure fingers are outside of trigger guard and pistol is pointed in a safe direction at all times!
2. Insert magazine firmly into the frame. Tug on magazine to insure that it is fully seated and engaged.
3. Retract the slide fully and release. Do not ride slide forward!
4. Engage safety lever or depress decocking lever.
5. Remove magazine and top off with one additional round.
6. Reinsert magazine insuring that it is fully seated.

READYING THE PISTOL FOR FIRING

Disengage the safety lever (if engaged). Red hazard dot will be visible above safety lever.

WARNING: (1) BE SURE OF YOUR TARGET AND WHAT IS BEHIND IT! Even a .45 caliber projectile can easily penetrate wood, plasterboard walls, or a car door, and can travel as far as one mile! (2) Ensure that all parts of your hand and body are kept away from the muzzle of the pistol at all time! (3) Always wear eye and ear protection where possible when firing the pistol. (4) Whenever the pistol is dropped on a hard surface landing on the hammer (cocked or down), it should be sent to the HK Customer Service Department as soon as possible to inspect the sear axle. If the sear axle is bent it should be replaced.

FIRING THE PISTOL

Single-action mode (hammer back/cocked) affords the operator the best and lightest trigger pull (approximately 4.8 lbs.) for precise and accurate bullet placement.

With manual safety disengaged:

1. Aim at the target.
2. Fire the weapon by pressing the trigger straight to the rear with gradually increasing pressure.
3. Engage the safety lever to remain in the single-action mode once firing is completed.

CAUTION: Single-action mode trigger pull is lighter and shorter than double-action mode. Keep your finger off the trigger and outside the trigger guard except when firing the Mark 23.

Double-action mode (Hammer down/uncocked) provides the operator with a long, heavy (12.1 lbs.) trigger pull for the first shot only. Subsequent shots will be fired in single-action mode as the slide will automatically cock the hammer after each round is fired. The double-action mode of fire is often the preferred mode of fire when safety during handling and carrying is of greater concern than first round accuracy.

1. Aim at the target.
2. Fire the weapon by pressing the trigger straight to the rear with gradually increasing pressure.
3. Depress the decocking lever to lower the hammer to return to the double-action mode once firing is complete, or engage the safety lever to remain in the single-action mode.

SECTION 6 — OPERATION UNDER UNUSUAL CONDITIONS

NOTE: Unusual conditions are defined as any climatic condition requiring special maintenance of the pistol. Perform the maintenance outlined for the climate that most applies to your operational area. Refer lubrication instructions.

CAUTION: If extensive corrosion is found and cleaning does not solve the problem, contact the HK Customer Service Department at (706) 568-1906.

EXTREME COLD

- A. When operating the pistol in extremely cold climates, clean and lubricate the pistol inside at room temperature if possible.
- B. Apply a light coat of LAW (Lubricant, Arctic Weapons) to all functional parts.
- C. To prevent freezing, keep the pistol covered when moving from a warm to a cold area. This will allow gradual cooling.
- D. Always keep the pistol dry.
- E. Do not lay a hot pistol in snow or ice.
- F. Keep ammunition dry; moisture will cause malfunctions. Do not lubricate the ammunition.
- G. Always keep snow out of the bore of the barrel. If snow should get into the bore, clean the bore before firing using a swab and cleaning rod.

HOT, WET CLIMATES

- A. Perform maintenance more frequently. Inspect hidden surfaces for corrosion. If corrosion is found, clean and lubricate.
- B. To help prevent corrosion, remove hand prints with a cloth. Dry and lubricate the pistol with CLP/LSA (Cleaner, Lubricant, Protectant).
- C. Check ammunition and magazines frequently for corrosion. Clean the magazine using CLP/LSA and wipe dry with a cloth. If necessary, clean ammunition with a dry cloth.
- D. Always keep mud out of the barrel. If mud should get into the bore, clean it before firing using a swab and cleaning rod.

HOT, DRY CLIMATES

- A. Dust and sand will get into pistol and cause malfunctions and excessive wear on component contact surfaces during firing. Keep the pistol covered when possible.
- B. Corrosion is less likely to form on metal parts in a dry climate. Therefore, lightly lubricate internal working surfaces only with CLP/LSA. Do not lubricate external parts of the pistol. Wipe any excess lubricant from exposed surfaces. Do not lubricate internal components of magazine.

HEAVY RAIN AND WATER OPERATIONS - ALL CLIMATES

- A. Perform maintenance in accordance with the appropriate climatic conditions.
- B. Always attempt to keep pistol dry.
- C. Always try to drain any water from barrel prior to firing. Dry the bore with a swab and cleaning rod.
- D. Lightly lube the bore and chamber. Generously lube internal and external surfaces of the pistol with CLP/LSA.
- E. In extreme or prolonged wet or saltwater conditions, cover serial number and proof mark on barrel and slide with a temporary protective coating. These are etched on the permanent protective coating on the barrel and slide and therefore may corrode under these conditions.

SECTION 7 — MALFUNCTIONS AND STOPPAGES

REMEDIAL ACTION

Remedial Action is the action performed to remedy an unanticipated interruption of the pistol's operation and place the pistol back into operation.

WARNING: During remedial action, make certain the pistol is pointed in a safe direction at all times.

- A. Clear the pistol!
- B. Attempt to lock slide.
- C. Remove magazine.
- D. Inspect chamber.
- E. Insert fresh magazine
- F. Release slide.
- G. Attempt to fire the pistol. If the Mark 23 fails to fire, contact the HK Customer Service Department at (706) 568-1906.

WARNING: If a round is assembled without powder (a fault of the manufacturing process), the primer alone has enough power to propel the projectile into the bore. A projectile lodged in the bore may cause damage to the barrel and/or the pistol if another round is fired and could cause personal injury. This event is commonly called a "pop and no kick" or "squib load" and is characterized by a much reduced report and little or no movement of the slide. An alert operator should notice the occurrence of this event in time to avoid firing the next round.

SECTION 8 — SELECTION AND USE OF A HOLSTER

SELECTION

When selecting a carrying holster for the HK Mark 23, it is important to consider the following points:

1. The holster must not make contact with or actuate any of the operating controls. This includes the hammer, slide release, magazine release lever, and most importantly the safety lever and the trigger. The design of the holster must also not actuate these controls when the pistol is carried in, drawn from, or returned to the holster.
2. The holster should not cause the slide to move (unlock) when the pistol is returned to the holster.
3. Accommodations must be provided in the holster for any accessories that might be present on the pistol.
4. Choose a holster designed for the Mark 23.

RETURNING THE PISTOL TO THE HOLSTER

The HK Mark 23 must be made "safe" (or cleared) prior to returning it to the holster. The pistol is considered safe to return it to the holster when:

1. All fingers are off of the trigger and out of the trigger guard.
2. The pistol is "Clear."
3. The hammer is in the decocked position.
4. The safety lever is engaged in the safe position when the hammer is cocked.

WARNING: The pistol must never be returned to the holster unless the above procedures have been followed or injury or death could occur.

SECTION 9 — MAINTENANCE INSTRUCTIONS

TOOLS & EQUIPMENT

The service life and performance of your HK Mark 23 is dependent upon the correct handling and proper care by the operator.

OPERATOR TOOLS AND EQUIPMENT REQUIRED

At a minimum, you will require the following materials to maintain the Mark 23 pistol and its components:

- Cleaning rod with handle and eyelet
- Long-handled nylon brush
- Bronze bristle bore brush (.45 caliber)
- Cotton swabs
- Solvent/bore cleaner/CLP
- Cleaning patches (.45 caliber)
- Rag

CAUTION: Use safety goggles when using solvents and exercise care if using compressed air.

PREVENTATIVE MAINTENANCE (PM) PROCEDURES

General - This PM service section lists those required checks and services to be performed by personnel who operate the Mark 23 pistol. This section includes the services required to prepare the pistol for operation, to check the pistol during operation, and to ensure proper function after maintenance. Before performing any PM service procedures, ensure that the Firearm Service Record has been updated with the correct round count and any PM service procedures documented. If your equipment fails to operate, refer to the Troubleshooting Table in Section III.

WARNING: Before starting an inspection procedure CLEAR THE PISTOL! Inspect the chamber to ensure that it is empty. Do not keep live ammunition near maintenance/work areas.

CAUTION: Hold the recoil/buffer spring assembly in place while removing the slide from the frame.

NOTE: Before starting any PM service procedure, ensure that the Firearm Service Record has been updated with the correct round count and any PM service performed documented.

DISASSEMBLY (FIELD STRIPPING)

Pistol

1. Clear the pistol!

2. Depress slide release and allow slide to move forward.
3. If applicable, remove any mounted accessories.
4. Retract and hold the slide to the rear approximately 22 mm until the front end of the slide release is centered on the recess visible on the left side of the slide (see Figure 2).
5. Push the slide release into the recess on the right side of the frame. Lift and completely remove the slide release from the left side of the frame (see Figure 10).
6. Remove the slide with barrel and captured recoil/buffer spring assembly off of the frame by sliding it forward (see Figure 13).

7. Remove the captured recoil/buffer spring assembly from the barrel and slide by lifting up on the rear of the guide rod. The entire assembly can now be lifted out of the slide.
8. Lift the rear of the barrel by the locking block and withdraw it from the slide.



Figure 8 Removing the Slide Release

Magazine

12-Round Magazine

1. Using a blunt pointed instrument, depress the locking detent protruding through the bottom of the magazine floorplate and hold it there.
2. Place a portion of either hand over the base of the magazine to control the release of the magazine spring and locking plate.
3. Slowly slide the floorplate forward off of the magazine housing.
4. Gradually allow the locking plate and magazine spring to expand out of the magazine housing.
5. Remove the locking plate, magazine spring and magazine follower from the magazine housing.

10-Round Magazine

1. Using a blunt pointed instrument depress the locking insert detente located in the floorplate and hold it there.
2. Place a portion of either hand over the base of the magazine to control the release of the magazine spring and locking insert.
3. With the locking detente still depressed, squeeze the floorplate locking tabs located on the right and left sides of the magazine.
4. Gradually allow the locking insert and magazine spring to expand out of the magazine housing.
5. Remove the locking insert, magazine spring and magazine follower from the magazine housing.

CAUTION: Beware of the spring tension exerted by the magazine spring while removing and installing the magazine floorplate. Keep the base of the magazine pointed in a safe direction (away from face and eyes) during disassembly and assembly.

CAUTION: Operator disassembly of the Mark 23 pistol is now complete. Only trained HK personnel should disassemble the weapon further.

REASSEMBLY (FROM FIELD STRIP)

12-Round Magazine

1. Place the magazine follower onto the end of the magazine spring having the loop at the end of the wire on the left side of the follower.
2. Insert the follower and the magazine spring into the magazine housing.
3. Place the locking plate onto the protruding end of the magazine spring so that the locking detent is visible (see Figure 11).
4. Push the locking plate down into the magazine housing against the pressure of the magazine spring and hold it there.
5. Slide the floorplate over the base of the magazine housing and locking plate from front to rear making sure that:
 - The floorplate engages the tabs located on the left and right sides of the magazine housing.
 - The floorplate is fully seated on the magazine housing.
 - The locking detent fits within the hole provided in the floorplate
 - Check the magazine for proper assembly by insuring that the follower slides up and down freely within the magazine housing and with spring tension. Also check that the magazine follower rises within the housing to be nearly flush against the bottom of the magazine lips.

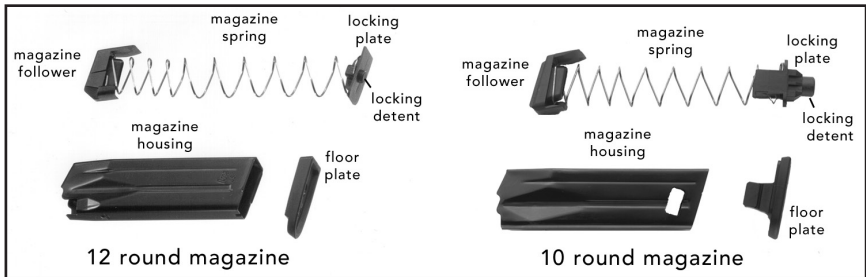

Figure 11 Disassembled 12 and 10 round magazines

10-Round Magazine (see Figure 11)

1. Place the magazine follower onto the magazine spring with the end of the spring positioned on the left of the follower.
2. Insert the follower and magazine spring into the magazine housing.
3. Place the locking insert (on 10-round magazines) onto the protruding end of the magazine spring so that the rounded corners face toward the front of the magazine.
4. Push the locking plate down into the magazine housing against the pressure of the magazine spring and hold it there.
5. Push the floorplate up onto the base of the magazine housing until the locking tabs engage in the sides of the housing. Check to see if the locking tabs on the floorplate are securely locked into the housing and the locking detente on the locking plate fits within the hole in the floorplate.
6. Check the magazine for proper assembly by insuring that the follower slides up and down freely within the magazine housing and with spring tension. Also check that the magazine follower rises within the magazine housing to be nearly flush against the bottom of the magazine lips.

Pistol Reassembly

1. Insert the muzzle of the barrel through the large hole located in the front of the slide.
2. Drop the barrel down into the slide and push it forward until the O-ring engages the slide, the locking block fits within the ejection port, and the angled locking surface of the locking block are visible along the bottom of the slide. The O-ring will now hold the muzzle tight in the front of the slide.
3. Install the captured recoil/buffer spring assembly into the slide so that the front of the recoil spring guide rod engages in the smaller hole located in the front of the slide.
4. Align the opposing angled locking surfaces of the recoil spring guide rod with those located on the bottom of the barrel locking block.
5. Push the rear of the recoil/buffer spring assembly forward enough so that the recoil spring retainer can be engaged on the shelf provided on the front of the barrel locking block (see Figure 12).
6. Hold the slide in the right hand with the thumb holding the rear end of the recoil/buffer spring assembly in place on the slide (see Figure 13).
7. Hold the frame in the left hand. Position the rear of the slide above the front edge of the frame.
8. Draw the slide back onto the frame so that the rails of the locking insert and guiding part slide within the grooves in the slide.
9. Retract the slide to the point where the recess in the left side of the slide is centered on the hole where the axle of the slide release will go.
10. Hold the slide in this position and insert the slide release from the left to right into the frame until it is flush with the side of the frame and locks in place.

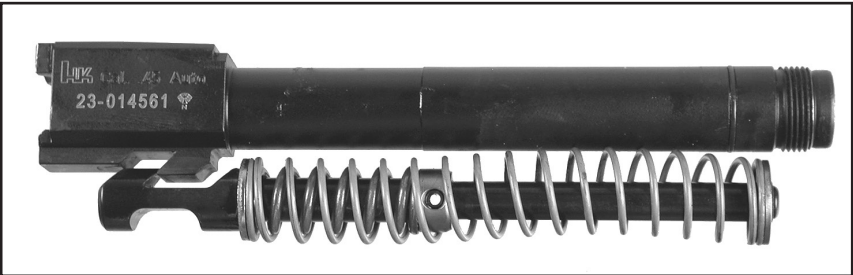

Figure 12 - Proper Position for the Captured Recoil/Buffer Spring Assembly on the Barrel Locking Block

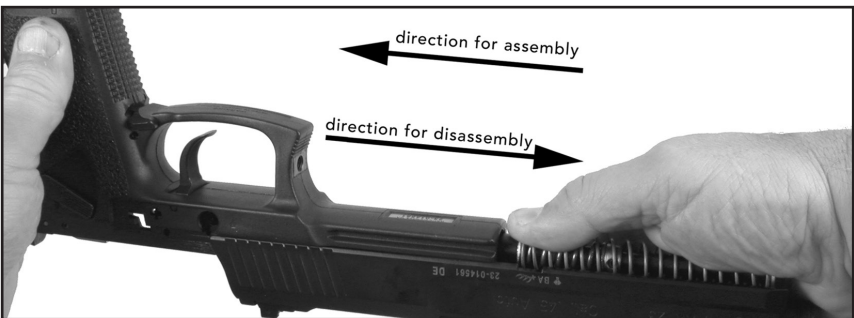

Figure 13 - Correct Position for Holding Slide for Disassembly & Reassembly

NOTE: Operator reassembly of the Mark 23 pistol is now complete, but not finished without a safety/function check.

SAFETY/FUNCTION CHECK

A safety/function check should be performed anytime the pistol is reassembled. This quick check indicates whether or not the pistol was properly assembled and with all the components. A properly executed safety/function check can also reveal many of the more obvious malfunctions that could occur between the interactive components of the pistol.

Always clear the pistol before performing a safety/function check! **Don't assume the pistol is clear.**

1. Clear the pistol!

2. Actuate the slide and the operating controls to insure that:

Magazine and catch - The magazine is held securely in place by the magazine catch and that it drops free of the frame when the catch is depressed.

Slide - The slide moves freely and without binding on the frame (with and without a magazine installed).

Barrel - The barrel locking block does lock fully into battery within the ejection port of the slide as the slide is closed.

Slide Release - The slide release does hold the slide open when retracted while:

- an empty magazine is in place
- the slide release is engaged (pressed upwards)
- The slide release does permit the slide to snap forward when:
 - the slide release is depressed
 - the slide is retracted without a magazine installed
- The slide release does rebound with spring pressure

3. Perform the following safety checks:

Safety Lever Test

1) With the pistol unloaded and hammer uncocked, attempt to press the safety lever upward

into the safe position. The safety lever should not engage. If the safety lever engages,

return the pistol to the HK Repair Department for service.

2) With the pistol unloaded and the hammer cocked, move the safety lever several times from the "safe" to "fire" position. If the safety lever does not have a pronounced stop when moved from "safe" to "fire" position and back, return the pistol to the HK Service Department for service.

3) With the pistol unloaded, cock the hammer and press the safety lever upward into the safe position. Grasp the pistol in the shooting position and squeeze the trigger three or four times. If the hammer falls, return the pistol to the HK Service Department for service.

Decocking Lever Test

1) With the pistol unloaded, cock the hammer and depress the decocking lever.

If the hammer does not fall or the decocking lever does not rebound (upward into its normal position) with spring pressure, return the pistol to the HK Service Department for service.

2) With the pistol unloaded, cock the hammer and press the safety lever upward into the safe position. Attempt to depress the decocking lever three or four times. If the hammer falls, return the pistol to the HK Repair Department for service.

Decocked (hammer disengaged) Test

NOTE: On the Mark 23 pistol when decocked (hammer down), the sear is engaged with the hammer at a rebounded stop position not touching the rear of the firing pin.

- 1) With the pistol unloaded, squeeze the trigger allowing the hammer to cycle in the double-action mode. After the hammer drops, retain pressure on the trigger. With the non-firing hand apply pressure with your finger tips on the rear of the hammer. The hammer should move forward toward the firing pin. Release pressure on the trigger while still retaining pressure with fingers on hammer. Release pressure on hammer. If the hammer fails to spring back into the stop position, return the pistol to the HK Repair Department for service.
- 2) With the pistol unloaded, hammer uncocked and trigger forward, apply pressure to the hammer with your finger tips. If the hammer moves forward to the firing pin, return the pistol to the HK Repair Department for service.

Disconnecter and Trigger Test

- 1) With the pistol unloaded, cock the hammer, push the slide rearward approximately 3/16 inches (2mm) and hold in that position while squeezing the trigger. If the hammer falls, return the pistol to the HK Repair Department for service.
- 2) With the pistol unloaded, pull the slide rearward until the slide stop will engage. Squeeze the trigger and release the slide forward simultaneously. If the hammer falls, return the pistol to the HK Repair Department for service.
- 3) With the pistol unloaded, pull the slide rearward and engage the slide. Squeeze the trigger and release the slide forward simultaneously. Release pressure on the trigger. If the trigger does not return to its normal position, return the pistol to the HK Repair Department for service. Squeeze the trigger and the hammer should fall. If the hammer does not fall, return the pistol to the HK Repair Department for service.
- 4) With the pistol unloaded and the trigger forward, apply thumb pressure to the cocked hammer. If the hammer disengages solely as a result of thumb pressure, return the pistol to the HK Repair Department for service.

FUNCTION FIRING

If any corrective action was accomplished, the pistol shall be function fired a full magazine prior to being cleaned and returned to service use.

CLEANING

Performed after each firing, every twelve (12) months, or after any exposure to extreme environmental conditions such as salt, fog, sand, dust, mud, water, etc.

Normal Cleaning -

1. Clear the pistol!

2. Disassemble the pistol into the major assembly groups.
 - **Slide** - Scrub all internal surfaces of the slide using the nylon brush moistened with solvent and remove all loose fouling from all surfaces of the slide using a rag and cotton swabs.
 - **Recoil/buffer spring assembly** - Remove all visible fouling using solvent, a nylon brush, a rag and cotton swabs.
 - **Barrel with locking block** - Moisten the bronze bore brush with solvent and scrub the bore from chamber to muzzle at least six passes, back and forth. (Note: Repeat steps 1 and 2 until a cleaning patch can be pushed through the bore and remains clean.)

NOTE: All parts of the Mark 23 can be immersed in any cleaning solvent that is safe to put your hands into. Gasoline and other motor fuels are not authorized cleaning solvents. Avoid cleaning the frame in an ultrasonic cleaner, as this can remove the colored "safe" and "fire" dots.

INSPECTION

During and after cleaning, the operator should inspect the pistol and its components for any irregularities that may cause problems during its operation. If any potential deficiencies are noted, they should be corrected immediately and/or brought to the attention of the HK Customer Service Department at (206) 568-1906 for service.

1. Visually Inspect the Pistol and Magazine for:
 - Damaged or missing parts
 - Improper assembly or function
 - Absence of free movement, where applicable
 - Absence of spring tension, where applicable.
2. Remove the loose fouling using cleaning patches.
3. Scrub outside surfaces of barrel and locking block with the nylon brush moistened with solvent.
4. Scrub the threads of the barrel and O-ring with the nylon brush moistened with solvent.
5. Remove all loose fouling using a rag and cotton swabs.
6. Frame - Scrub all internal surfaces where carbon fouling is visible using the nylon brush moistened with solvent. Concentrate on the area normally covered by the slide. Using the rag and cotton swabs, remove all loose fouling from all areas of the frame.
7. Magazine - Disassembled the magazine for cleaning. Scrub the top of the magazine, concentrating on the follower and feed lips, using the nylon brush moistened with solvent. Using the rag and cotton swabs, remove all loose fouling from all surfaces of the magazine.
8. Unaccustomed looseness
9. Parts exhibiting signs of cracks, burrs, dents or obvious signs of damage or stress
10. Presence of stops or tactile clicks in controls, where applicable
11. General overall cleanliness
12. Presence of proper lubrication
13. Presence of corrosion or degradation of surface finish
14. Rubber hammer spur for cracks or chips

CAUTION: If the rubber hammer spur is badly cracked or chipped, drop safety could be degraded. Pistol should be returned to HK Service Department to replace hammer.

LUBRICATION

All metal surfaces of the Mark 23 pistol have a special surface treatment that resists all types of corrosion including corrosion resulting from exposure to salt water. However, this surface treatment does not reduce friction between parts; therefore, lubricant must be applied to the pistol. Any type of high-quality, medium weight lubricant (oil or grease) specifically designed for use on firearms, such as "Break-Free" (C.L.P.), will work well on the Mark 23 pistol. Do not use lubricants that boast of their ability to penetrate metal as these substances may deaden primers.

A. Where and how much?

No Lube - (surface is dry and not slippery to the touch)

- Plastic components

Light Lube - (finger run across surface yields little or no lube)

- Bore, chamber and exterior of barrel
- All metal parts
- All internal parts in slide and frame
- Magazine housing and spring
- Recoil/buffer spring assembly
- Sights
- O-ring

Medium Lube - (finger run across surface yields some lube but lube does not run down surface when held in a vertical position)

- Barrel locking block
- Slide rails
- All operating controls
- Locking insert and guiding part
- Extractor

Heavy Lube - (lube runs down surface when held in a vertical position)

NOTE: No heavy lube is required on the Mark 23 pistol.

Reapply lubrication periodically during firing as it burns off from the heat. Apply lubricant using a shaving brush, cotton swabs, patches or rag. A spray bottle also works well using compressed air to circulate the lubricant into all parts and to remove the excess.

SECTION 10 — ADJUSTMENT OF SIGHTS

Description -

1. The mechanical sights supplied with the Mark 23 pistol are comprised of a fixed front sight post combined with a rear sight with u-shaped notch of a conventional configuration. Both front and rear sights are held in place on the slide within a standard dovetail groove. The rear sight is also secured with a retaining screw and is adjustable for windage and elevation.
2. Both front and rear sights contain white circles (or cylindrical tritium capsules) that appear as dots to the operator. One dot is positioned on either side of the rear sight aperture and in the center of the front sight post. When the sights are properly aligned vertically and horizontally, so are these dots. Thus, the three dots can be used for rapid acquisition of the sights and proper sight alignment.

Adjustment - The battle sight zero of the Mark 23 pistol is easily adjusted by moving or replacing the rear sight.

NOTE: All windage and elevation adjustments are made using only the rear sight.

Windage adjustments - To adjust the horizontal (left and right) impact of the projectile, follow the steps below:

1. Clear the Pistol!

2. Note the index mark on the rear sight and its relationship to the index mark on the slide.
3. Loosen the rear sight retaining screw using a screw driver.
4. With a small hammer and brass or soft metal drift punch, drift the sight to the:
 - LEFT to move the point of impact to the left.
 - RIGHT to move the point of impact to the right.
 - The amount of movement will depend on the individual shooter and the ammunition used.

NOTE: Always strike the sight on the sight base, not on the sight blades.

5. Retighten the rear sight retaining screw.
6. Confirm your battlesight zero by firing the pistol again.

Elevation Adjustments - To adjust the vertical (up and down) impact of the projectile, follow the steps below:

1. Clear the pistol!

2. Determine the amount of vertical change, in inches, that is required at 25 meters.

NOTE: The index mark on the rear sight and its relationship to the index mark on the slide.

3. Loosen and remove the rear sight retaining screw using a screw driver.
4. With a small hammer and brass or soft metal drift punch, drift the sight completely out of either side of the dovetail groove.
5. Note: The marking on the bottom of the rear sight (the standard sight is unmarked).
6. Select a higher or lower rear sight from Figure 14.
7. Using the brass or soft metal punch and hammer, install the new sight into the dovetail groove.

8. Align the index marks of the rear sight and slide as noted in Step b above.
9. Reinstall and tighten the rear sight retaining screw.
10. Confirm your battlesight zero by firing the pistol again.

Rear Sight Selection - The rear sight is marked with -6, -4, -2, unmarked, +2, +4, or +6. This marking represents the amount of vertical change, in inches, that occurs when that sight is exchanged with the sight originally installed in the pistol.

- To RAISE the point of impact, install a higher rear sight.
- To LOWER the point of impact, install a lower sight.

Example: The pistol is shooting 4-inches high at 25 meters. We want the pistol to shoot dead-on (point of aim, point of impact). The rear sight removed from the pistol is unmarked (standard).

- Figure 25 shows that the rear sight marked -4 would lower the point of impact two increments, or a total of 4 inches, from the standard unmarked rear sight removed from the pistol.
- The -4 sight would be the correct one to install.

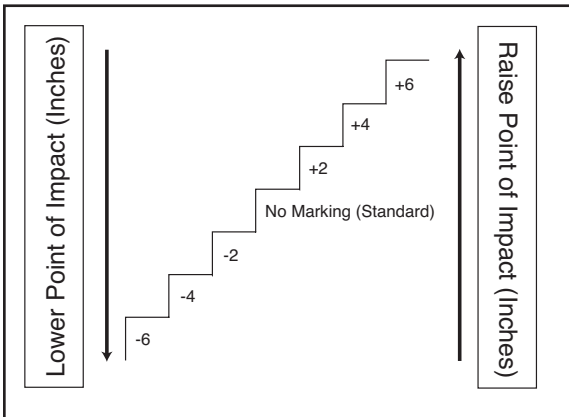

Figure 14

Zeroing

1. The battlesight zero of the Mark 23 pistol is set by the manufacturer using +P 185 grain JHP ammunition. The pistol is fired from a machine rest at a target positioned 25 meters from the pistol. The pistol is zeroed point of aim, point of impact (POA/POI). This means the impact of the projectile on target will coincide with the point of aim of the sights at 25 meters.
2. Each individual operator of the Mark 23 pistol can battlesight zero their pistol to their unique shooting style by adjusting the sights in accordance with the procedures in paragraphs 1-3 above.

SECTION 11— TROUBLESHOOTING PROCEDURES

PROBLEM SYMPTOM / CAUSE / REMEDY

Stoppage	Cause	Remedy
Round does not feed	Fouled magazine or pistol	Clean and lube pistol and magazine
	Improperly assembled	Assemble correctly
	Incorrect loading procedure used	Load pistol in accordance with instructions in operator's manual
	Unserviceable magazine	Replace magazine
Round does not chamber	Dirty or damaged magazine	Clean and lube or replace magazine
	Obstruction present in chamber and/or bore	Remove obstruction, clean and lube chamber/bore
	Bent or damaged recoil spring, buffer spring or guide rod. Buffer spring retainer roll pin drift. *	Return pistol to the HK Service Depart for service
Slide does not lock fully forward	Fouled barrel locking block or slide	Clean and lube barrel locking block and slide
	Dry component parts or pistol	Lubricate pistol in accordance with instructions in operator's manual
	Damaged or burred slide, barrel locking block or recoil/buffer spring assembly. Buffer spring retainer roll pin drift. *	Return pistol to the HK Service Department for service

Stoppage	Cause	Remedy
Pistol does not fire	Faulty ammunition Little or no sign of firing pin strike (indent) on primer	Replace ammunition Return pistol to the HK Service Department for service
Slide does not unlock	Faulty ammunition, determined by short recoil Check for broken or damaged slide, barrel locking block or recoil/buffer spring assembly. Buffer spring retainer roll pin drift.*	Check bore for obstruction and replace ammunition Return pistol to the HK Service Department for service
Cartridge does not extract	Fouled chamber Ruptured cartridge case in chamber Fouled or corroded ammunition Pitted or damaged chamber Broken or damaged extractor or extractor spring	Clean and lube Remove ruptured case, clean and lube chamber Replace ammunition Return pistol to the HK Service Department for service Return pistol to the HK Service Department for service
Operating controls do not function as described in operator's manual	Damaged or improperly assembled component parts	Return pistol to the HK Service Department for service
Accuracy degradation	Damaged or missing O-ring	Replace O-ring

***NOTE: Always inspect the buffer spring retainer roll pin for drift. If not firmly seated and centered in the guide rod, return to the HK Service Department for replacement.**

SECTION 12 WARRANTY

WARRANTY REGISTRATION

New HK firearms are covered by Heckler & Koch, Inc.'s Limited Lifetime Warranty. Warranty registration is now online. To register your new HK firearm, go to: <https://hk-usa.com/warranty/registration/>

If you do not have access to the Internet, contact Heckler & Koch, Inc. to obtain a warranty registration form:

HK Customer Service
5675 Transport Boulevard
Columbus, GA 31907
Telephone: 706-701-5554.
Email: cs@heckler-koch-us.com

HECKLER & KOCH, INC. LIMITED LIFETIME WARRANTY

All new Heckler & Koch, Inc. firearms purchased after January 1, 1998, are warranted to the original retail purchaser only for the lifetime of the said original retail purchaser. In the event that this original retail purchaser, at the time of the original purchase, shall donate this firearm to another person, the donee name must be submitted during the online warranty registration. Heckler & Koch, Inc. does not guarantee or warrant that any, all, or some donations or gifts are valid and compliant with all applicable laws, regulations, and ordinances. Heckler & Koch, Inc. is not responsible or liable in any way for a donation or gift that does not comply with applicable laws, regulations, and ordinances. It is the responsibility of the original retail purchaser and the donee or recipient to ensure that any such transfer complies with all applicable laws, regulations, and ordinances. Upon completion of the online warranty registration indicating the name of the said donee, this warranty shall be extended to the lifetime of the said donee. This warranty applies only if the firearm was imported into the United States and distributed by Heckler & Koch, Inc. to an authorized dealer.

What Will We Do?

Heckler & Koch Inc. will, at its option, repair or replace without charge any HK firearm that fails due to a defect in materials or workmanship. Parts and labor are included. Repairs are warranted for the duration of the warranty. If Heckler & Koch, Inc. replaces a firearm under this warranty; you will receive a new warranty. Heckler & Koch, Inc. will return your firearm to you shipping pre-paid.

How to Obtain Service:

Contact Heckler & Koch, Inc. via phone at 706-701-5554 or email at cs@heckler-koch-us.com for a Return Authorization Number before sending your firearm freight prepaid to Heckler & Koch, Inc. at the address listed below. No C.O.D. shipments will be accepted.

Only the existing Heckler & Koch, Inc. Service Center or any other authorized Heckler & Koch, Inc. Service Center that may be established by Heckler & Koch, Inc. shall be authorized to make warranty repairs.

Return the complete, unloaded firearm with a detailed description of the problem using Heckler & Koch, Inc.'s Return Form.

DO NOT send any live ammunition with the firearm. If you must send ammunition to us for proof purposes, be sure that it is sent separately from the firearm.

We strongly recommend that you complete the online warranty registration at <https://hk-usa.com/warranty/registration/> to establish eligibility for warranty service. If you do not return an acknowledgment of online warranty registration to Heckler & Koch, Inc., you are required to provide adequate proof of the date that you purchased your new HK firearm at the time you send your firearm to Heckler & Koch, Inc. for warranty service.

In the event that this firearm was given as a gift at the time of original purchase, the online warranty registration with the name of the donee must be provided to Heckler & Koch Inc., in order for the warranty to become effective.

Note: Non-warranty servicing must follow the same shipping procedures as stated above. HK firearms with a valid Return Authorization Number should be shipped to the following address in accordance with these instructions:

HKI
Attn: Service Department/RA# _____
5675 Transport Blvd.
Columbus, GA 31907

Any information gathered in connection with a Heckler & Koch Inc. lifetime limited warranty shall be used for that purpose and may be used for other legitimate business purposes of Heckler & Koch Inc. For further information, please review Heckler & Koch, Inc.'s Privacy Policy, located at <https://hk-usa.com/cookie-policy-us/>

What Is Not Covered?

This warranty does not cover defects or damage caused by: (1) unreasonable use; (2) failure to provide proper care or maintenance; (3) failure to comply with instructions in the operator's manual including improper installation of original Heckler & Koch Inc. parts by the owner or his agent; (4) normal wear and tear for the degree of use; (5) rust or corrosion; (6) obstructions in the barrels; (7) excessive use; and/or (8) finish on the bolt carrier assembly.

Heckler & Koch, Inc. reserves the right to determine what constitutes the unreasonable or excessive use of the firearm. All wooden parts and all accessories are excluded from warranty coverage.

This warranty does not cover any claims made by the second or subsequent owner of an HK firearm as stated above.

NOTICE Any unauthorized alteration or modification of the firearm or use of parts or components not originally made by Heckler & Koch, Inc. may void this warranty. Heckler & Koch, Inc. is not be responsible for any claims involving this firearm that result from the use of faulty, nonstandard, remanufactured, or reloaded ammunition or ammunition not manufactured to NATO, CIP, and/or SAMMI specifications.

Under no circumstances shall Heckler & Koch, Inc. be responsible or liable for incidental or consequential damages with respect to loss of use, loss of business or profits, other economic loss or injury to property, whether as a result of breach of express or implied warranty, negligence or otherwise. This Limited Lifetime Warranty applies only to retail purchases by individuals through an authorized Heckler & Koch, Inc. dealer.

Residents of CALIFORNIA, CONNECTICUT, DISTRICT OF COLUMBIA, HAWAII, MARYLAND, MASSACHUSETTS, MICHIGAN, NEW JERSEY, NEW YORK, AND U.S. TERRITORIES.

Any work involving replacement of the receiver of a firearm requires that the firearm be returned to a licensed firearms dealer. A current, signed copy of the dealer's FFL will be required. Please provide contact information for the chosen dealer, if applicable.

NOTICE Customers in restrictive capacity states: **DO NOT ship high capacity magazines to Heckler & Koch Inc. They cannot be returned.**

Exclusions

This lifetime warranty explicitly excludes firearms purchased by the United States military, government institutions or agencies of the United States or any of its constituent states and territories, law enforcement agencies of the United States or any of its constituent states and territories, and/or security organizations located within the United States or any of its constituent states and territories. Firearms purchased by these entities and organizations for duty issue to their personnel and/or employees are covered by a one-year limited warranty against material defects and workmanship or as agreed upon in a valid contract.

This lifetime warranty also excludes rimfire .22L R firearms, and all suppressors, which are covered by a one-year warranty.

Some states do not allow the exclusion or limitation of incidental or consequential damages, so the above limitations or exclusions may not apply to you. This warranty gives you specific legal rights, and you may also have other rights, which vary from state to state. This limited warranty is the only express warranty by Heckler & Koch Inc.

Heckler & Koch Inc. does not authorize any dealer or any other person to vary the terms of this warranty or make any other express warranties.

Heckler & Koch, Inc. Lifetime Barrel Guarantee

Heckler & Koch, Inc. guarantees the serviceability of the bore of the barrels of all MR A4 Series rifles and pistols for the lifetime of the original consumer purchaser for individual use. This guarantee is based on barrels meeting standards on accuracy, velocity, and useability across the entire life of the A4 system. If at any time an A4 barrel fails to meet these standards, Heckler & Koch, Inc. will replace the barrel.



Where to Get Further Help

If you have questions concerning this warranty, please contact Heckler & Koch, Inc.'s Customer Service Department at:
5675 Transport Blvd.
Columbus, GA 31907
Telephone: 706-701-5554
Email: cs@heckler-koch-us.com

SECTION 13 — PARTS LIST AND EXPLODED DIAGRAM

Position Number	Item Description	Part Number	Position Number	Item Description	Part Number
1	extractor	215707	38	decocking lockout	215745
2	extractor spring	215708	39	hammer axle	215738
3	rear sight retaining screw	215711	40	hammer, complete	215772
4	rear sight, 6.3mm standard (unmarked)	215770	41	hammer rebound spring	215739
	rear sight, 5.5mm (-4)*	215767	42	hammer strut	215740
	rear sight, 5.9mm (-2)*	215768	43	hammer strut spring	215741
	rear sight, 6.7mm (+2)*	215771	44	insert	215731
	rear sight, 7.1mm (+4)*	215774	45	locking bolt	215732
	rear sight, 7.5mm (+6)*	215783	46	frame	215976
5	front sight	215721	47	safety detent	215746
6	firing pin	215705	48	safety detent spring	215747
7	firing pin spring	215706	49	left safety lever	215769
8	firing pin block	215709	50	decocking lever	215766
9	firing pin block spring	215710	51	magazine release pin	986432
10	firing pin retaining pin	986432	52	magazine release spring	215737
11	extractor pin	986432	53	magazine release	215775
12	slide	215667	54	slide release spring	215733
13	barrel	215671	55	trigger	215735
14	O-ring	986429	56	trigger pin	215736
15	recoil spring guide rod	215724	57	slide release lever, complete	215763
16	recoil spring retainer	215725	58	magazine housing (12-rd magazine)	215778
17	buffer spring	215726	58A	magazine housing (10-rd magazine)*	215672
18	dual roll pin (buffer spring retainer)	929908	59	follower (10 & 12-rd magazine)	215779
19	buffer spring retainer	215727	60	locking plate (12-rd magazine)	215781
20	spring ring	929191	60A	locking plate (10-rd magazine)*	214853
21	washer	215728	61	floorplate (12-rd magazine)	215780
22	recoil spring	215729	61A	floorplate (10-rd magazine)*	215673
23	trigger bar, complete	215760	62	magazine spring (12-rd magazine)	215782
24	trigger bar spring	215734	62A	magazine spring (10-rd magazine)*	214821
25	c-clip (decocker)	927062	63	locking insert (molded into frame)	
26	decocking spring	214743	64	trigger guard insert (molded into frame)	
27	decocker 215742		65	guiding part (molded into frame)	
28	roll pin (ejector)	986431		12-rd magazine, complete*	215668
29	ejector	215752		10-rd magazine, complete*	215670
30	sear	215748			
31	sear spring	215749			
32	sear actuator	215750			
33	disconnecter	215751			
34	sear axle	215753			
35	roll pin (right safety lever)	986430			
36	right safety lever	215744			
37	sear block	215754			

*not pictured

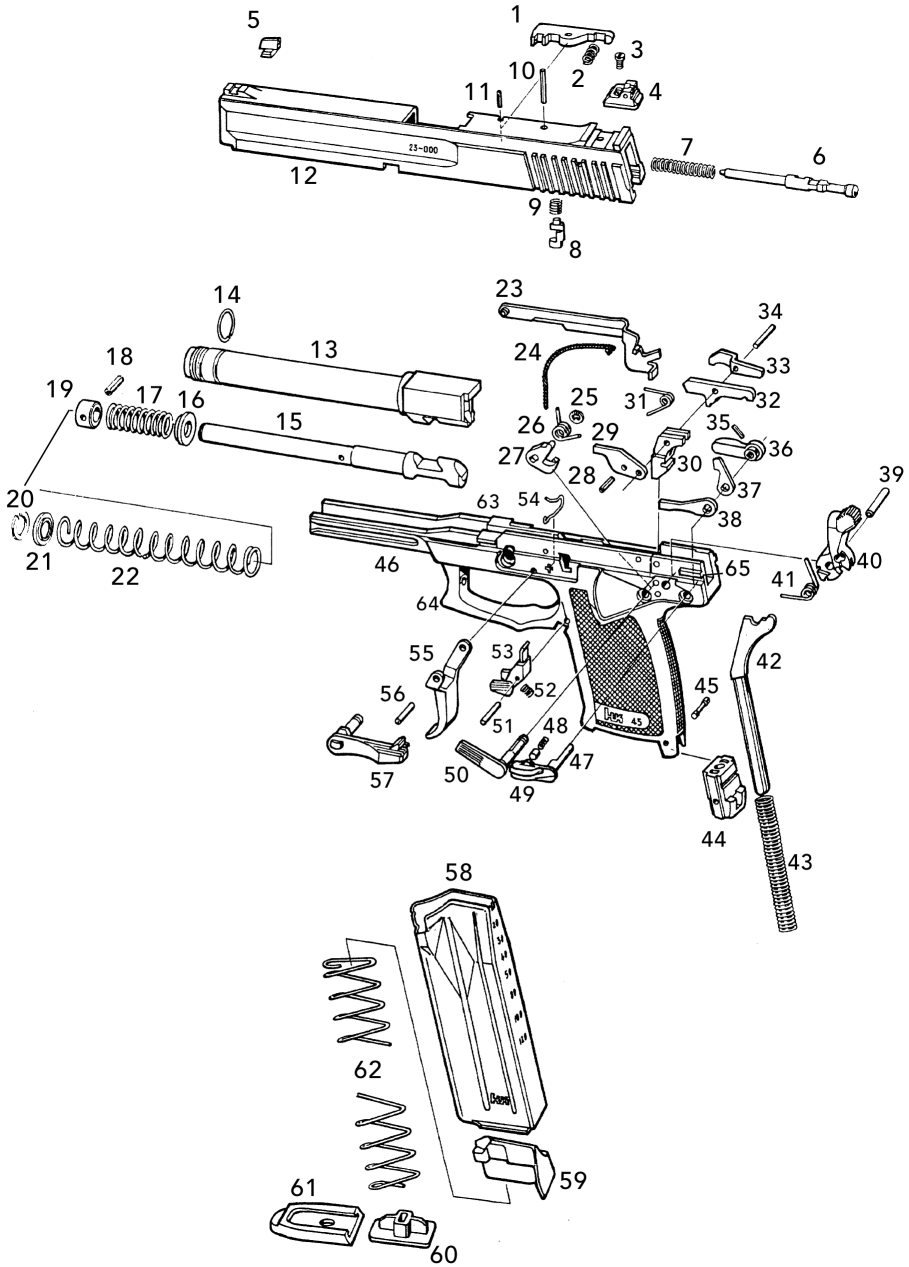

Figure 15 Mark 23 / MK23 Exploded Diagram

SECTION 14 — HK LOCK-OUT DEVICE

Mark 23 pistols produced and delivered in the U.S. after 1999 are equipped with a patented HK Lock-Out™ Device. This component replaces the lanyard loop insert in the frame and when engaged locks the handgun's action by blocking any movement of the trigger, the hammer, and the slide. The handgun is locked and cannot fire until unlocked. The Lock-Out control plate is accessible through the pistol's magazine well (see Figures 16-18).

WARNING: Always point the pistol in a safe direction when locking or unlocking the Lock-Out Device. The pistol should be unloaded and "clear" before locking the Lock-Out Device.

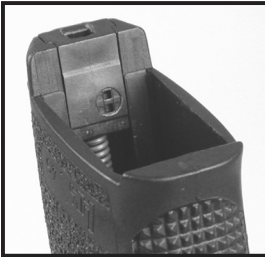

Figure 16
Unlocked/FIRE position



Figure 17
Turn the key clockwise
to lock the action



Figure 18
Locked/SAFE position

Use the two pronged key supplied with the pistol to lock or unlock the pistol as desired. When the holes on the Lock-Out Device are horizontally positioned the pistol is locked and cannot be fired (see Figure 18).

NOTE: Either type of lockout key will work with the Mark 23 (see Figure 19).

When the holes on the Lock-Out Device are vertically positioned the pistol is unlocked and can be fired (see Figure 16).

WARNING: The HK Lock-Out Device is not a substitute for safe gun handling practices. Never point the muzzle of the pistol in an unsafe direction (at yourself or others). When the Lock-Out Device is placed in the locked position the slide is locked in the closed position and cannot be moved! Forcing the slide rearward while the gun is in this locked position will damage the pistol.

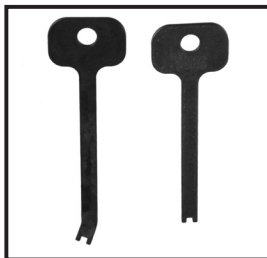

Figure 19 Lockout Keys



HECKLER & KOCH
5675 Transport Boulevard
Columbus, Georgia 31907
United States of America
Tel: (706) 568-1906
Fax: (706) 568-9151
American Website: www.hk-usa.com